

МОЩНЫЙ СВЕТОДИОД ARPL-25/31W-LTA-1919-97

ОСОБЕННОСТИ

- Высокая световая эффективность (>100 лм/Вт)
- Высокий индекс цветопередачи (CRI>97)

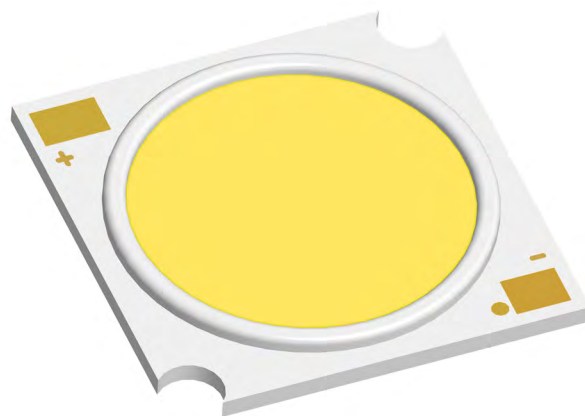

ПРИМЕНЕНИЕ

- Светодиодные светильники (трековые, даунлайты)

ГАБАРИТНЫЕ РАЗМЕРЫ

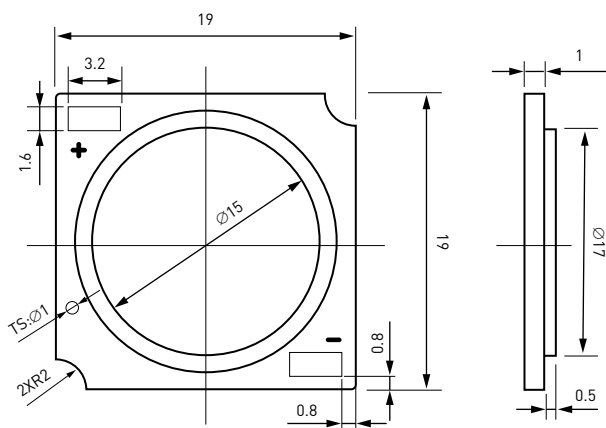

Notes: All dimensions in mm.
The tolerances unless mentioned are ± 0.3 , unit=mm.

LIMIT PARAMETERS

| Parameter | Symbol | Min | Max | Unit |
|-----------------------|-----------|-------------|-------------|-------------|
| Forward Current | I_F | / | 1840 | mA |
| Forward Voltage | V_F | 33.6 | 39.6 | V |
| Operating Temperature | T_{opr} | -10 | +85 | °C |
| Storage Temperature | T_{stg} | -40 | +100 | °C |
| Soldering Temperature | T_{sol} | / | 350 | °C |
| Junction Temperature | T_j | / | 125 | °C |
| Thermal Resistance | R_{j-c} | / | 0.57 | °C/W |
| Antistatic Ability | ESD | 2000 | / | V |

The using temperature is less than 85°C; please reduce the using current or contact with us if using temperature is more than 85°C.
When hand soldering, keep the temperature of iron below less 350°C less than 5 seconds.

ELECTRO-OPTICAL CHARACTERISTICS

($I_f = 1200 \text{ mA}$, $T_c = 25 \text{ °C}$)

| CCT | CRI, min Ra | R9 | Luminous Flux Min | Typ | Efficacy (typ), lm/W | Voltage (typ), V |
|---------------|----------------|-----------|----------------------|-------------|-------------------------|---------------------|
| 3000 K | 97 | 70 | 4290 | 4515 | 101 | 36.5 |
| 4000 K | 97 | 70 | 4440 | 4665 | 105 | 36.5 |

The tolerance of measurement at our tester is voltage $\pm 5\%$, luminous flux $\pm 7\%$ and Ra\R9 ± 1 .
Luminous flux inside the integrating sphere measurements.

| Art. | CRI | I_f | flux |
|---------------|-----------|---------------|-----------------|
| 034738 | 97 | 720 mA | 2 840 lm |
| 034479 | 97 | 720 mA | 2 840 lm |
| 034743 | 97 | 900 mA | 3 500 lm |
| 034742 | 97 | 900 mA | 4 440 lm |

CHROMATICITY COORDINATE GROUPS

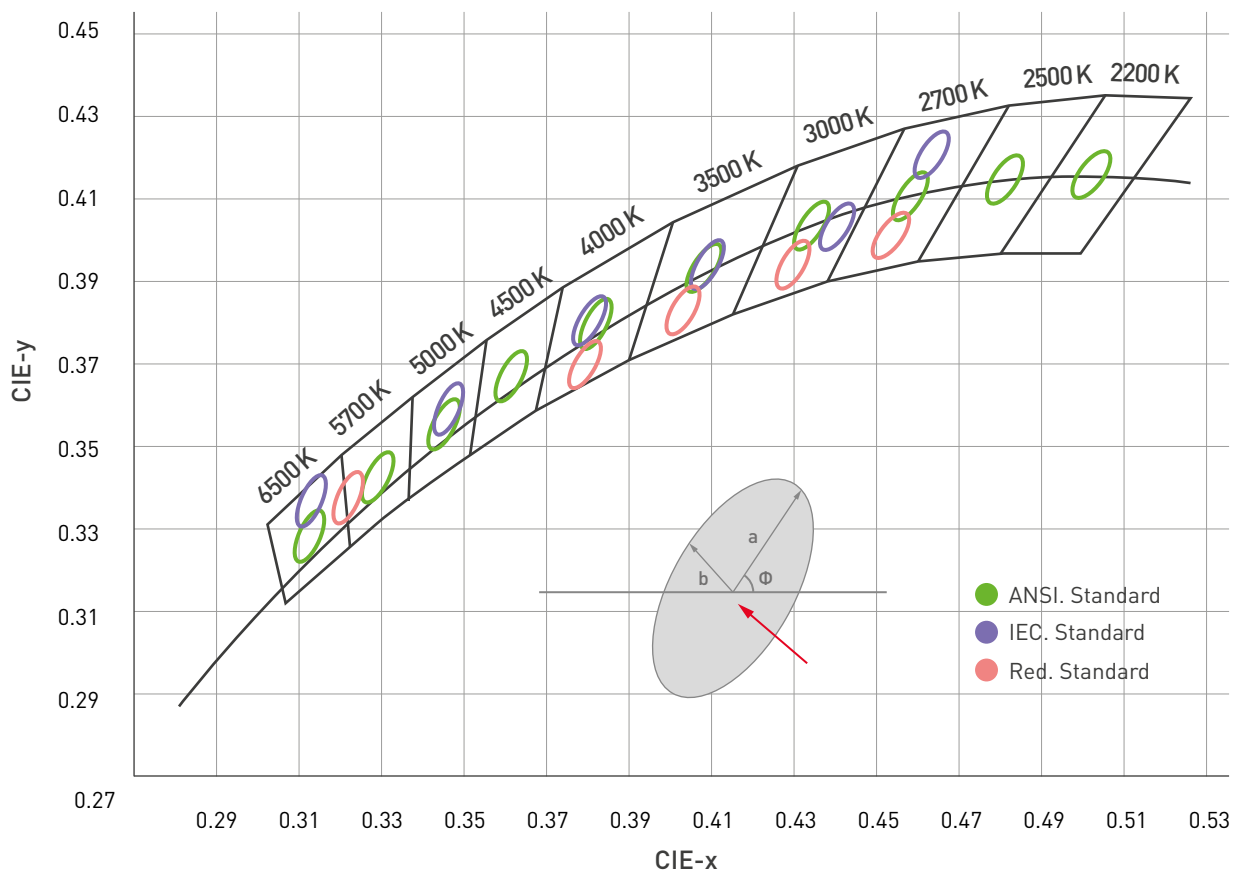

CHARACTERISTIC CURVES

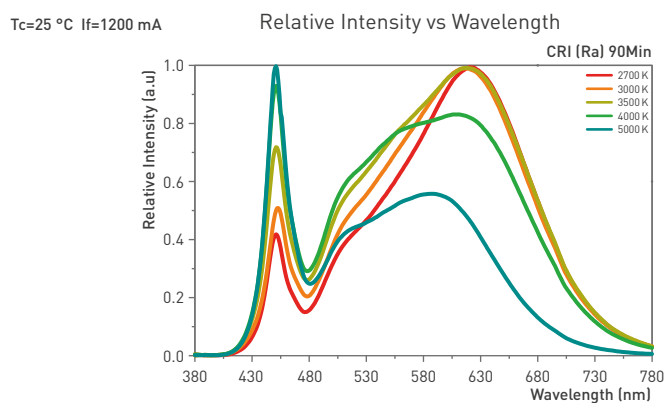
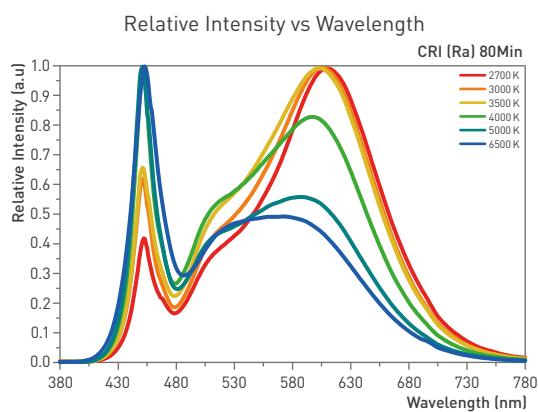
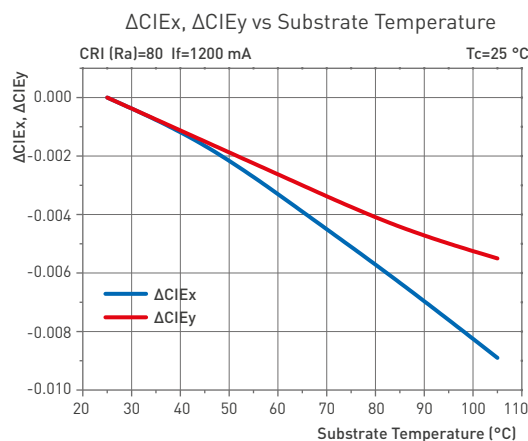
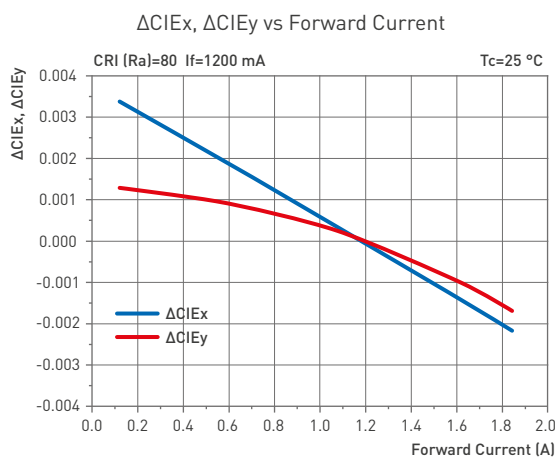
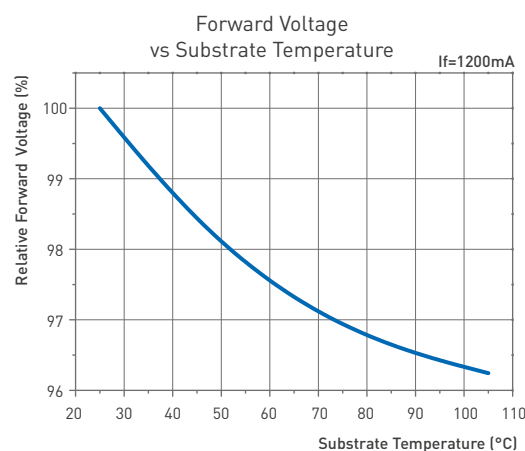
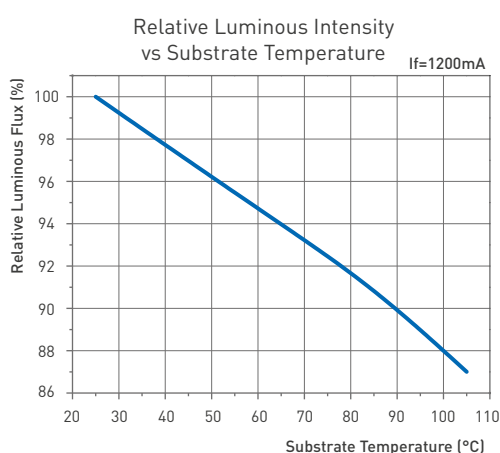
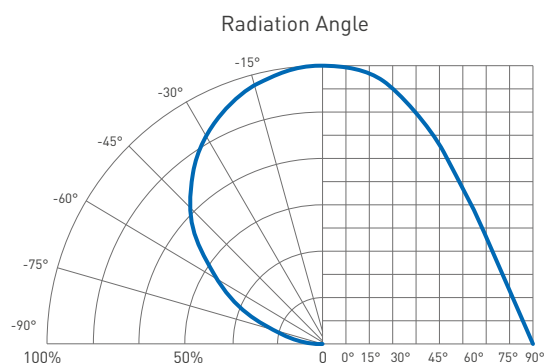
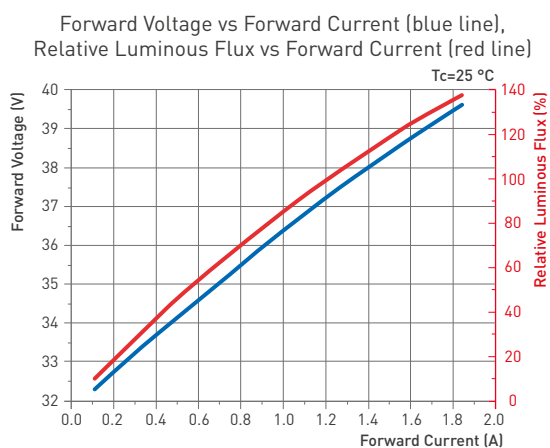

УПАКОВКА

