

ARPL-1W Red (1R1N)



FEATURES

- Long operating life
- Highest flux
- Available in Red
- Lambertian radiation pattern
- More energy efficient than incandescent and most halogen lamps
- Low voltage DC operated
- Cool beam, safe to the touch
- Instant light (less than 100ns)
- Fully dimmable
- No UV
- Superior ESD protection
- RoHS compliant

APPLICATIONS

- Fiber optic alternative/Decorative/entertainment
- Mini-acct/Up lighters/Down lighters/Orientation
- Indoor/Outdoor commercial and Residential Architectural
- Cove/Under shelf/Task
- Bollards/Security/Garden
- Portable(flashlight,bicycle)
- Edge-lit signs (Exit,point of sale)
- Automotive Exit (Stop-Tail-Tum, Chmsl, Mirror Side Repeat)
- Traffic signaling/Beacons/RailCrossing and Wayside

RADIATION PATTERN

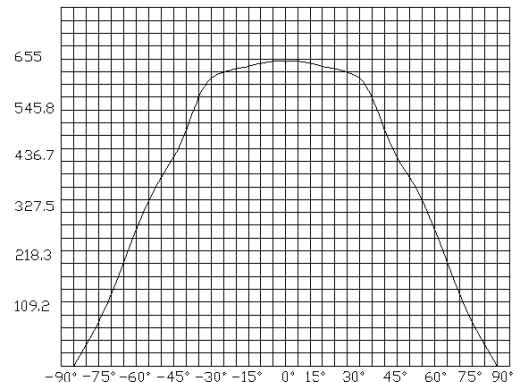
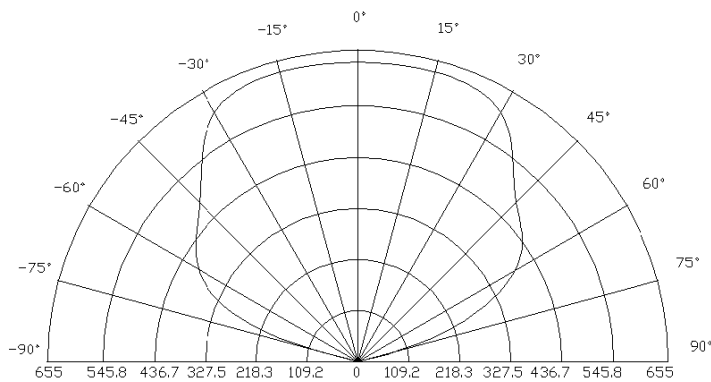

ELECTRICAL / OPTICAL CHARACTERISTICS AT TA=25°C

Item	Symbol	Condition	Min.	Typ.	Max.	Unit
Forward Voltage	$V_F (R)$	IF=350mA	2.0	--	2.8	V
Reverse Current	I_R	VR=5V	--	--	30	uA
50% Power Angle	$2\theta_{1/2}$	IF=350mA	120		140	deg
Luminous Intensity	$\phi_V(R)$	IF=350mA	34.9	39.8		lm
Recommend Forward Current	I_F	--	--	--	350	mA
Wave Length	λ_d	IF=350mA	620		630	nm
Thermal Resistance,Junction to Case	RJP	IF=350mA	--	10	--	°C/w

Notes:

1. Tolerance of measurement of forward voltage $\pm 0.1V$.
2. Tolerance of measurement of peak Wavelength $\pm 2.0nm$.
3. Tolerance of measurement of luminous intensity $\pm 15%$.

ABSOLUTE MAXIMUM RATING

Item	Symbol	Absolute Maximum Rating	Unit
Forward Current	I_F	350	mA
Peak Forward Current*	I_{FP}	500	mA
Reverse Voltage	V_R	5	V
Power Dissipation	P_D	1000	mW
Electrostatic discharge	E_{SD}	± 2000	V
Operation Temperature	T_{OPR}	-40~+80	$^{\circ}C$
Storage Temperature	T_{STG}	-40~+100	$^{\circ}C$
Lead Soldering Temperature*	T_{SOL}	Max. 260 $^{\circ}C$ for 3sec Max.	

*IFP Conditions: Pulse Width ≤ 10 msec duty $\leq 1/10$

* All high power emitter LED products mounted on aluminum metal-core printed circuit board, can be lighted directly, but we do not recommend lighting the high power products for more than 5 seconds without a appropriate heat dissipation equipment.

* Re-flow, wave peak and soak-stannum soldering etc.is not suitable for this products.

* Suggest to solder it by professional high power LED soldering machine.

* Can use invariable-temperature searing-iron with soldering condition: ≤ 260 degree less than 3 seconds.

TYPICAL OPTICAL/ELECTRICAL CHARACTERISTICS CURVES ($T_a=25^{\circ}C$ Unless Otherwise Noted)

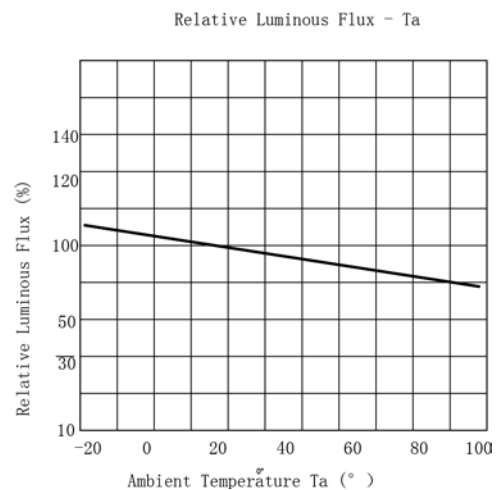
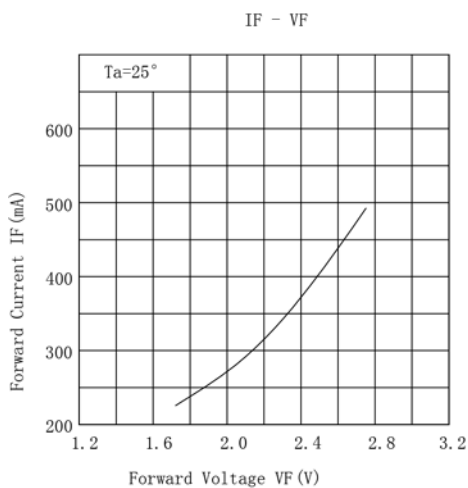
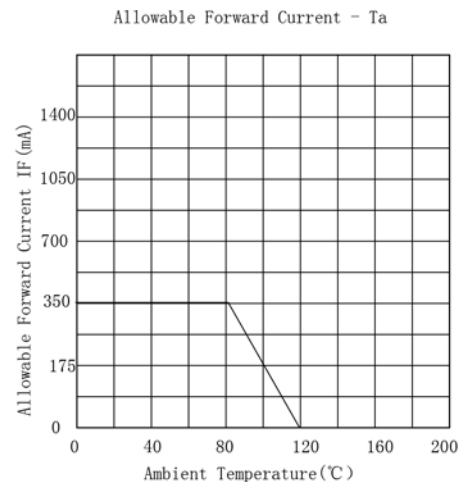
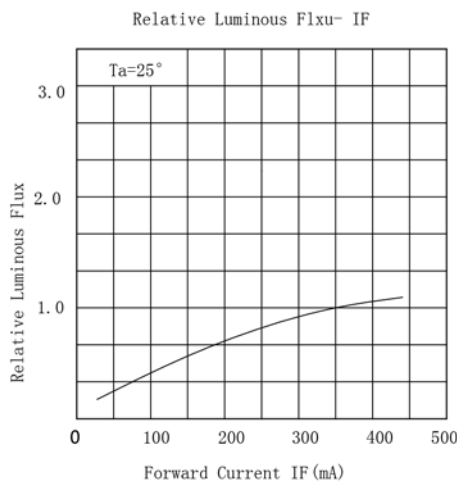

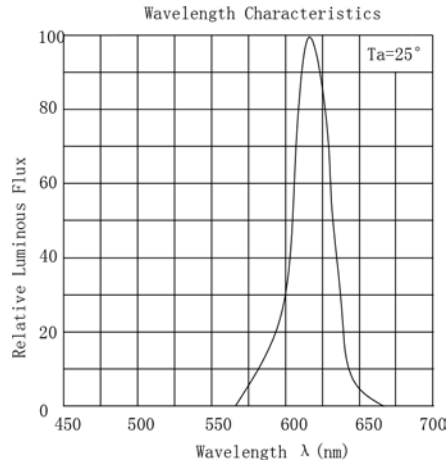

PACKAGE DIMENSIONS

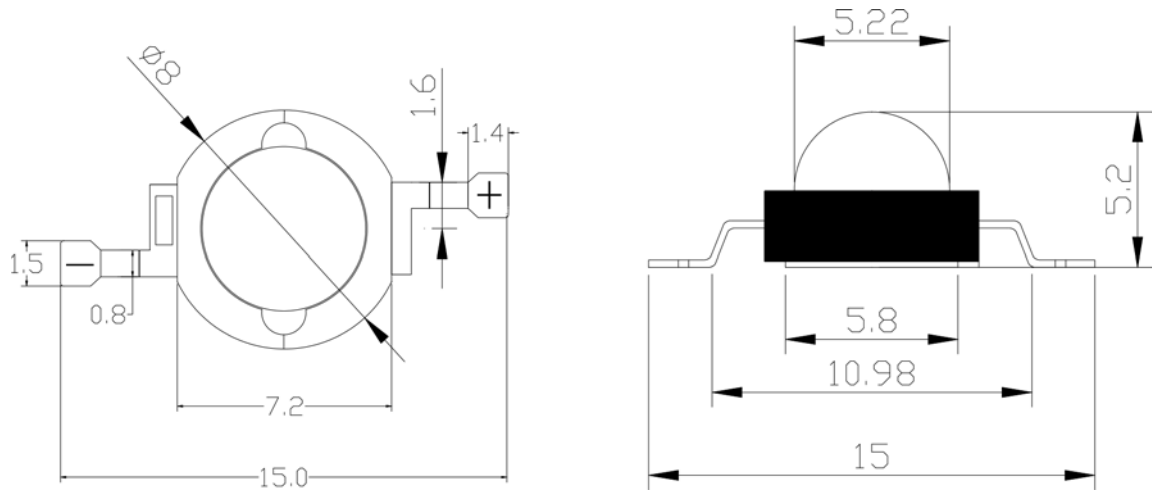

Notes:

1. All dimension units are millimeters.
2. All dimension tolerance is $\pm 0.2\text{mm}$ unless otherwise noted.

