

User manual



**KOHBEPTEP  
KNX-301-72-TUYA-DIN  
(BUS, ZigBee)**

Арт. 037759



**KNX/EIB Home and Building Control System**

# Attentions

1. Please keep devices away from strong magnetic field, high temperature, wet environment;



2. Do not fall the device to the ground or make them get hard impact;



3. Do not use wet cloth or volatile reagent to wipe the device;



4. Do not disassemble the devices.

## Contents

Chapter 1. Summary .....	1
Chapter 2. Technical Data .....	2
Chapter 3. Dimension and Structural Diagram .....	3
3.1. Dimension Diagram .....	3
3.2. Structural Diagram .....	3
Chapter 4. Project Design and Programming .....	4
Chapter 5. Parameter setting description in the ETS .....	6
5.1. Parameter window “General” .....	6
5.1.1. Parameter window “General setting” .....	6
5.1.2. Parameter window “IP setting” .....	7
5.2. Parameter window “KNX Channel” .....	8
5.2.1. Parameter window “General setting” .....	8
5.2.2. Parameter window “KNX Channel setting” .....	9
5.2.3. Parameter window “Channel x”{x=1~150} .....	10
5.2.3.1. Parameter of basic function .....	12
5.2.3.2. Parameter of air condition .....	15
5.2.3.3. Parameter of room temperature unit .....	17
5.2.3.4. Parameter of ventilation system .....	20
5.2.3.5. Parameter of audio control .....	23
5.2.3.6. Parameter of sensor function .....	24
5.2.3.7. Parameter of current metering function .....	27
5.2.3.8. Parameter of energy metering function .....	28
5.3. Parameter window “Zigbee Channel” .....	29
5.3.1. Parameter window “Zigbee Channel setting” .....	29
5.3.2. Parameter window “Channel x” {x=1~32} .....	30
5.4. Parameter window “Room temperature controller” .....	34
5.4.1. Parameter window “RTC Channel setting” .....	34
5.4.2. Parameter window “RTC x”{x=1~10} .....	34
5.4.2.1. Parameter window “Setpoint” .....	40
5.4.2.2. Parameter window “Heating/Cooling control” .....	42
5.4.2.3. Parameter window “Fan” .....	48
5.5. Parameter window “Ventilation controller” .....	52
5.5.1. Parameter window “Control setting” .....	52
5.6. Parameter window “Logic” .....	59
5.6.1. Parameter window “AND/OR/XOR” .....	60
5.6.2. Parameter window “Gate forwarding” .....	62
5.6.3. Parameter window “Threshold comparator” .....	63
5.6.4. Parameter window “Format convert” .....	65
5.6.5. Parameter window “Gate function” .....	66

5.6.6. Parameter window “Delay function” -----	68
5.6.7. Parameter window “Staircase lighting” -----	68
<b>Chapter 6. Description of Communication Object -----</b>	<b>70</b>
6.1. “General” Communication Object -----	70
6.2. “KNX Channel” Communication Object -----	70
6.2.1. Communication Object of basic function -----	71
6.2.2. Communication Object of Air condition -----	78
6.2.3. Communication Object of Room temperature unit -----	80
6.2.4. Communication Object of Ventilation system -----	84
6.2.5. Communication Object of Audio control -----	86
6.2.6. Communication Object of sensor function -----	89
6.2.7. Communication Object of current/energy metering -----	92
6.3. “Zigbee Channel” Communication Object -----	93
6.4. “Room temperature controller” Communication Object -----	98
6.5. “Ventilation controller” Communication Object -----	101
6.6. “Logic” Communication Object -----	102
6.6.1. “AND/OR/XOR” Communication Object -----	102
6.6.2. “Gate forwarding” Communication Object -----	103
6.6.3. “Threshold comparator” Communication Object -----	104
6.6.4. “Format convert” Communication Object -----	104
6.6.5. “Gate function” Communication Object -----	107
6.6.6. “Delay function” Communication Object -----	108
6.6.7. “Staircase lighting” Communication Object -----	109
<b>Chapter 7. UI Description for Tuya Smart APP -----</b>	<b>110</b>
7.1. Add device -----	110
7.2. Device information -----	114
7.3. Switch interface -----	115
7.4. Switch/Dimming interface -----	116
7.5. RGB Dimming interface -----	117
7.6. Curtain control interface -----	118
7.7. Value sender interface -----	120
7.8. KNX Scene switch interface -----	121
7.9. Air condition interface -----	123
7.10. Room temperature unit interface -----	124
7.11. Ventilation system interface -----	125
7.12. Audio control interface -----	126
7.13. Sensor interface -----	127
7.14. Current/Energy metering interface -----	129
7.15. Voice control command -----	130
<b>Chapter 8. Tuya Zigbee Gateway Management System -----</b>	<b>138</b>
8.1. Gateway information -----	139
8.2. ZigBee device list -----	140

<b>8.3. ZigBee function list</b>	<b>141</b>
<b>8.4. Linking the ZigBee device</b>	<b>142</b>
<b>Chapter 9. OTA for KNX Gateway for Tuya ZigBee</b>	<b>146</b>

## Chapter 1. Summary

KNX Gateway for Tuya ZigBee as the interface between KNX system and Tuya ZigBee system, realizing the connection between the Tuya ZigBee ecosystem and the KNX system. Based on the gateway, it can easily control the KNX devices with Tuya APP, and upload status information of KNX devices to Tuya platform, for monitoring and managing the devices conveniently.

This manual provides detailed technical information about the KNX Gateway for Tuya ZigBee, including installation and programming details, and explains how to use it in the practical examples. After setting up KNX Gateway for Tuya ZigBee on the ETS, you can smartly manage the KNX and Zigbee system products, add and use the devices through the supporting mobile APP—Tuya Smart.

KNX Gateway for Tuya ZigBee powered from KNX bus, and need a 12-30V DC auxiliary supply voltage. It is available to assign the physical address and configure the parameters by engineering design tools ETS with .knxprod ( support edition ETS5.7 or higher ).

The functions are summarized as followed:

- ▼ As a ZigBee Gateway function, it can connect to Tuya Cloud, and add ZigBee device of Tuya ecosystem to the cloud
- ▼ Support uploading KNX devices to Tuya platform for management, to control KNX device and display status
- ▼ Support KNX devices functions, including Switch, Dimming, Curtains, Scenes, Color and Color temperature control, Audio control, HVAC control(Room temperature control, Air conditioner and Ventilation system), multiple sensors(Air Quality, Temperature and humidity, Brightness, Gas, I/O signal and etc.), and Current, Energy Metering display
- ▼ Logic functions
- ▼ Support bidirectional communication between ZigBee and KNX

## Chapter 2. Technical Data

<b>Power Supply</b>	Bus voltage	21-30V DC, via the KNX bus
	Bus current	<4.5mA, 24V <4mA, 30V
	Bus consumption	<120 mW
<b>Auxiliary Supply</b>	Voltage	12-30V DC
	Current	<60mA, 24V <50mA, 30V
	Consumption	<1.5W
<b>Connection</b>	KNX	Bus connection terminal(Red/Black)
	Auxiliary Supply	Bus connection terminal(Yellow/White)
	LAN	RJ45 socket for 100 Mbit and 10 Mbit BaseT, IEEE 802.3 networks
	Antenna	Rubber rod antenna or extension antenna (3m)
	Wireless communication	Network without barriers:>100m Network with barriers:>10m ( Across two walls)
<b>Operation and display</b>	Connect button	Long press 5s will disconnect gateway
	Connect status LED	On: connecting; Off: connected Fast flashing: Tuya authorization code is abnormal  (Unprogram)
	LAN LED	On: connected; Off: disconnected Flashing: Data communication
	Programming button and LED	Red on: assign physical address Green flashing: running normally
<b>Temperature</b>	Operation	- 5 °C ... 45 °C
	Storage	- 25 °C ... 55 °C
	Transport	- 25 °C ... 70 °C
<b>Environment</b>	Humidity	<93%, except dewing
<b>Design</b>	Standard 35mm DIN rail installation	
<b>Dimension</b>	36 x 90 x 64 mm	
<b>Weight</b>	0.15 kg	

## Chapter 3. Dimension and Structural Diagram

### 3.1 Dimension Diagram

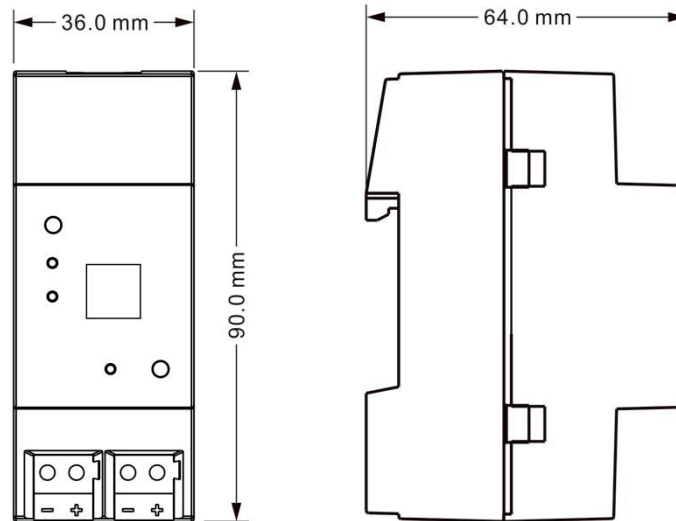

### 3.2 Structural Diagram

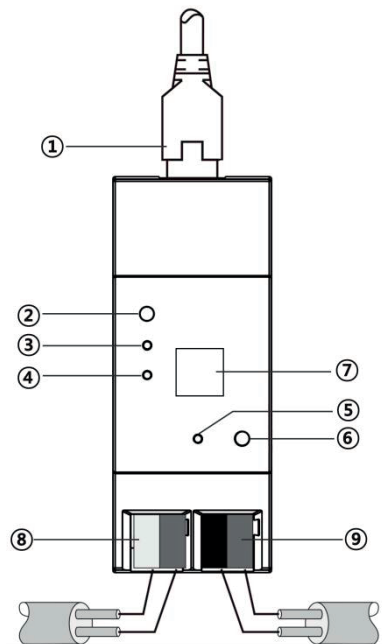

- ① LAN connection
- ② Connect button
- ③ Connect status LED
- ④ LAN LED
- ⑤ Programming LED
- ⑥ Programming button
- ⑦ Antenna interface
- ⑧ Auxiliary supply connection terminal
- ⑨ KNX bus connection



## Chapter 4. Project Design and Programming

Application	Maximum of communication objects	Maximum number of group addresses	Maximum number of associations
<b>KNX-301-72-TUYA-DIN</b>	<b>3933</b>	<b>8000</b>	<b>8000</b>

### General function

General function includes device In operation setting and IP setting.

### KNX channel function

Support to upload the KNX device to the Tuya platform for management, which to control the device and display status. Up to support 150 devices. Each device can be customized its name with the engineering design tools ETS, and has In operation setting to monitor whether the device is online and upload to APP.

Top 100 device channels support the whole functions, including switch, dimming, curtain, scene switch, color and color temperature (RGB, RGBW and color temperature), audio control, HVAC control (Room temperature control, Air conditioner and Ventilation), multiple sensors (Air quality, humidity and temperature, brightness, gas, I/O signal and etc.), and current, energy display.

The latter 50 device channels only support the functions, including switch, dimming, curtain, air quality sensor and energy display.

**Note: Request each device status when the gateway power on.**

### **Zigbee channel function**

Support bidirectional communication between ZigBee and KNX device, for integrating Zigbee devices into KNX system, up to 32 device data points, which can be set with name and MAC address information on the ETS. Use the website (Tuya Zigbee Gateway Management System) to configure and manager the linkage between Zigbee devices and KNX system.

Support to control the following Zigbee devices with the KNX system:

Sensor: Air quality sensor, Temperature and humidity sensor, Brightness sensor, Gas sensor, and I/O signal (Switch, Boolean, Alarm,Occupancy sensor,Window/door sensor);

Zigbee lamp: lamp, dimmable lamp, RGB bulb/strip, color temperature light and RGBCW bulb;  
Electric curtain.

### **Room temperature controller**

Up to support 10 room temperature controllers. Mainly used to control the room temperature, Automatically and optimally cooling/heating control according to the room use or the occupants needs.

Support to manual switch to heating/cooling control, optionally three fan speeds and the auto fan speed, 4 operation modes: comfort, standby, economy and protection mode.

The temperature setpoint value supports the relative setting method, and is adjustable range setting. Support 2 points and PI control.

### **Ventilation controller**

Support 1 ventilation controller, and fan speed can be linked to PM2.5/CO2/VOC, optionally output types of 1bit of 1byte.

### **Logic function**

Up to support 8 channels oflogic, each channel up to support 8 inputs and 1 logic result.

Logic function support functions, including AND, OR, XOR, Gate forwarding, Threshold comparator, Format convert, Gate function, Delay function and Staircase lighting.

## Chapter 5. Parameter setting description in the ETS

### 5.1. Parameter window “General”

#### 5.1.1. Parameter window “General setting”

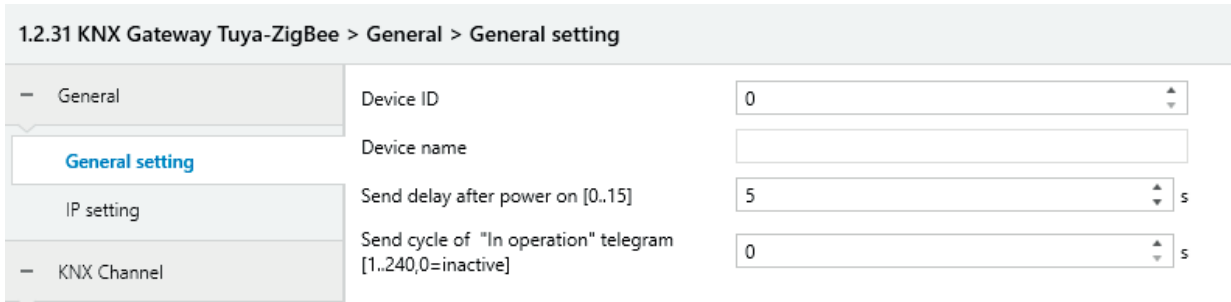

1.2.31 KNX Gateway Tuya-ZigBee > General > General setting		
General	Device ID	0
General setting	Device name	
IP setting	Send delay after power on [0..15]	5 s
KNX Channel	Send cycle of "In operation" telegram [1..240,0=inactive]	0 s

Fig.5.1.1 “General setting” Parameter window

#### Parameter “Device ID”

This parameter is for setting the device ID. Options: **0...65535**

#### Parameter “Device name”

This parameter is for setting the device name. Up to input 32 characters.

#### Parameter “Send delay after power on [0..15]s”

This parameter is for setting the delay time to send to bus after the gateway power on. Options: **0..15**

The setting dose not contain the gateway initialization time, and bus telegrams received during delay time will be recorded.

#### Parameter “Send cycle of “In operation” telegram[1...240s, 0 = inactive]”

This parameter is for setting the time interval when this device cycle send telegrams through the bus to indicate this module in normal operation. When set to “0”, the object “in operation” will not send a telegram. If the setting is not “0”, the object “In operation” will send a telegram according to the set period time with logic “1” to the bus. Options: **0...240s, 0= inactive**

As to reduce the bus load as much as possible, the maximum time interval should be selected according to actual needs.

### 5.1.2. Parameter window “IP setting”

1.2.31 KNX Gateway Tuya-ZigBee > General > IP setting

General	IP assignment	<input type="radio"/> DHCP <input checked="" type="radio"/> Fixed
General setting	IP address (device)	<input type="text" value="192.168.1.10"/>
<b>IP setting</b>	Default Gateway	<input type="text" value="192.168.1.1"/>
KNX Channel	Subnet Mask	<input type="text" value="255.255.255.0"/>
	DNS server	<input type="text" value="192.168.1.1"/>

Fig.5.1.2 “IP setting” Parameterwindow

#### Parameter “IP assignment”

This parameter is for setting the assignment of IP address. Options:

##### **DHCP**

##### **Fixed**

Fixed: the assignment of IP address is fixed, can be assigned address for device via the parameters as follow.

DHCP: the parameters as follow are not visible when DHCP enabled, and no need to configure.

#### —Parameter “IP address (device)”

This parameter is for setting the IP address of device, and the IP address must be unique in the LAN, otherwise causing a conflict between IP.

Enter the address in IPv4 format, for example: 192.168.1.10

Options: **0-255.0-255.0-255.0-255**

#### —Parameter “Default Gateway”

This parameter is for setting the default gateway. That is the default gateway of network segment which the device connects to.

Enter the address in IPv4 format, for example: 192.168.1.1

Options: **0-255.0-255.0-255.0-255**

#### —Parameter “Subnet Mask”

This parameter is for setting the subnet mask. That is the subnet mask of network segment which the device connects to.

Enter the address in IPv4 format, for example: 255.255.255.0

Options: **0-255.0-255.0-255.0-255**

#### —Parameter “DNS server”

This parameter is for setting the DNS server of device.

Use string with IPv4 to input address, for example: 192.168.1.1

Options: **0-255.0-255.0-255.0-255**

## 5.2. Parameter window “KNX Channel ”

### 5.2.1. Parameter window “General setting”

1.2.31 KNX Gateway Tuya-ZigBee > KNX Channel > General setting

General	Status object read request after restart	<input checked="" type="checkbox"/>
General setting	Send request delay between status objects	100 ms
IP setting	<b>Device online status request setting for common x</b>	
KNX Channel	Time period request for common 1 [0..255,0=inactive]	0 min
General setting	Time period request for common 2 [0..255,0=inactive]	0 min
KNX Channel setting	Time period request for common 3 [0..255,0=inactive]	0 min
Zigbee Channel	Time period request for common 4 [0..255,0=inactive]	0 min
Room temperature controller	Time period request for common 5 [0..255,0=inactive]	0 min
Ventilation controller	Time period request for common 6 [0..255,0=inactive]	0 min
Logic	Time period request for common 7 [0..255,0=inactive]	0 min
	Time period request for common 8 [0..255,0=inactive]	0 min
	Time period request for common 9 [0..255,0=inactive]	0 min
	Time period request for common 10 [0..255,0=inactive]	0 min

Fig.5.2.1 “General setting” Parameter window

#### Parameter “Status object read request after restart”

This parameter is for setting whether to send read request telegram of status after restart device.

#### Parameter “Send request delay between status objects”

This parameter is visible when previous parameter is enabled. Set the interval time for sending between request telegrams when power on. Options:

**50ms**

**100ms**

**200ms**

#### Device online status request setting for common x

#### Parameter “Time period request for common x [0..255,0=inactive] min”(x=1~10)

This parameter is for setting the read request period to send to query the online status of the common device, 0 is not enable query function. Options: **0..255**

The function is used to query the online status of the KNX device. Requests begin after the gateway power-up send delay time complete.

### 5.2.2. Parameter window “KNX Channel setting”

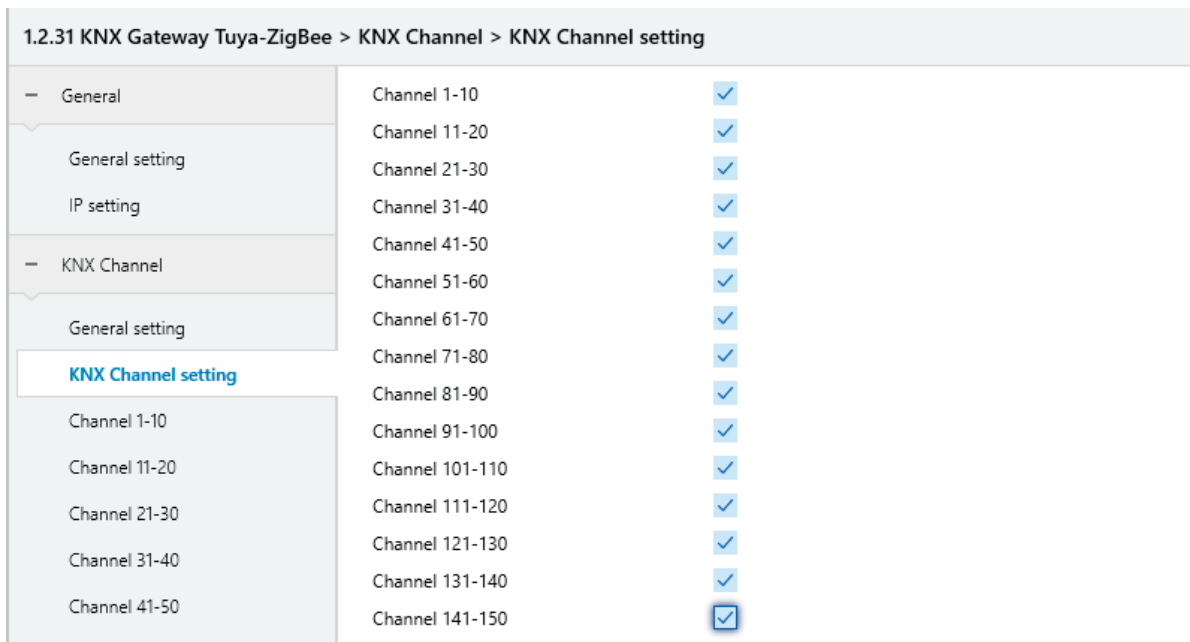

Fig.5.2.2(1) “KNX Channel setting” Parameter window

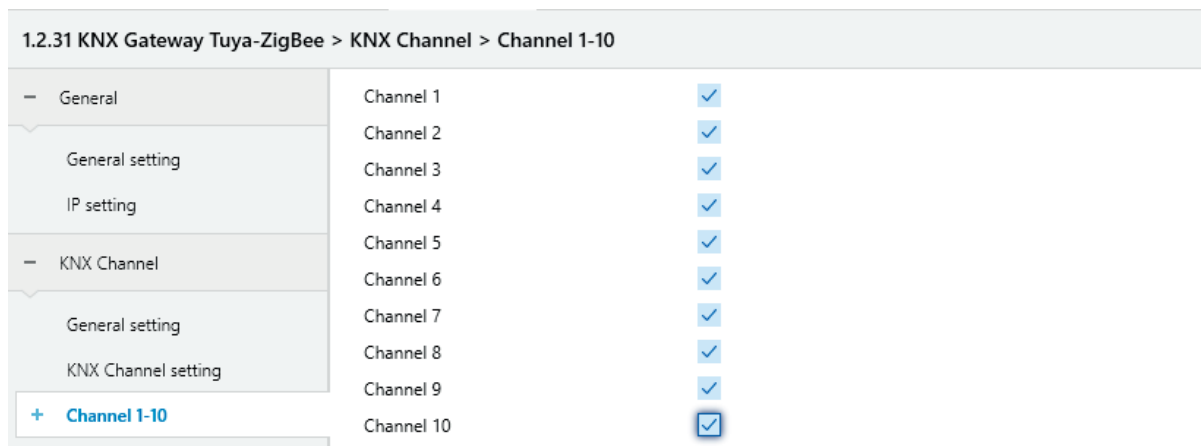

Fig.5.2.2(2) “Channel 1-10” Parameter window

#### Parameter “Channel 1-10/11-20/21-30/...”

This parameter is for setting the enable KNX device. Display 10 KNX channels per page when enabled. Up to support 150 channels.

#### Parameter “Channel 1/2/3/...”

This parameter is for setting the KNX device setting. Display corresponding window when enabled.

### 5.2.3. Parameter window “Channel x”(x=1~150)

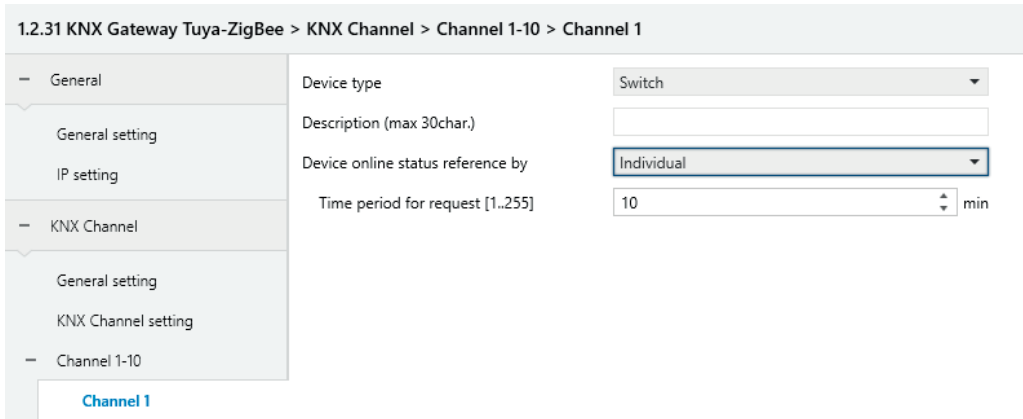

Fig.5.2.3 “Channel 1” Parameter window

Parameters as follow is general setting parameters for KNX device type. Later chapters will not be repeated.

#### Parameter “Device type”

**Note: do not change KNX Channel Device type parameter when this channel is added to Tuya. First delete existing device, otherwise you will not be able to delete it and you will need to delete KNX-Tuya gateway**

This parameter is for setting the device type of KNX channel. Options:

- |   |                                   |
|---|-----------------------------------|
| <b>Switch</b>   | <b>Ventilation system</b>         |
| <b>Switch/Dimming</b>   | <b>Audio control</b>              |
| <b>RGB dimming</b>  | <b>Audio control(with on/off)</b> |
| <b>RGBW dimming</b>   | <b>Air quality sensor</b>         |
| <b>Color temperature</b>  | <b>CO2 sensor</b>                 |
| <b>Curtain step/move</b>  | <b>PM2.5 sensor</b>               |
| <b>Rollerblind step/move</b>                                      | <b>VOC sensor</b>                 |
| <b>Curtain position</b>   | <b>Presence sensor</b>            |
| <b>Rollerblind position</b>                                       | <b>Motion sensor</b>              |
| <b>Venetian blind position and slat</b>                           | <b>Brightness sensor</b>          |
| <b>Value sender</b>   | <b>I/O signal</b>                 |
| <b>Scene switch</b>   | <b>Current metering</b>           |
| <b>Air conditioner</b>  | <b>Energy metering</b>            |
| <b>Air conditioner(with swing)</b>                                |                                   |
| <b>Room temperature unit</b>                                      |                                   |
| <b>Room temperature unit(with operation mode)</b>                 |                                   |
| <b>Room temperature unit(with operation mode &amp; fan speed)</b> |                                   |

**Note: Channel 1~100 support all of the above function options, but channel 101~150 only support the functions as follow:**

- Switch**
- Switch/Dimming**
- Curtain step/move**
- Rollerblind step/move**
- Air quality sensor**
- Energy metering**

### **Parameter “Description (max 30char.)”**

This parameter is for setting the name description for current channel device, up to input 30 characters.

### **Parameter “Device online status referenceby”**

This parameter is for setting the reference type sending read request to KNX device, you can select request for individual or common device, and optionally 10 common device requests. Options:

**Common 1**

...

**Common 10**

**Individual**

**Always online**

When select “Common ...”, common device request, apply to the device with multiple circuits. For example, multiple channels of gateway may be multiple circuits that control the same KNX device, so each channel can share one request.

When select “Individual”, apply to a device only is controlled by gateway single channel.

When select “Always online”, apply to the KNX device without heartbeat pack, especially scene. That is, once configure the device, it will always online.

### **——Parameter “Time period for request [1..255] min”**

This parameter is visible when “Individual” is selected, set the time period for the online status request of single device. Options: **1..255**



### 5.2.3.1. Parameter of basic function

This chapter explains the basic functions parameters of KNX channel, including switch, dimming, curtain, color, color temperature, value sender and KNX scene switch.

1.2.31 KNX Gateway Tuya-ZigBee > KNX Channel > Channel 1-10 > Channel 1

General	Device type	Switch
General setting	Description (max 30char.)	
IP setting	Device online status reference by	Individual
KNX Channel	Time period for request [1..255]	10 min
General setting		
KNX Channel setting		
Channel 1-10		
Channel 1		

Parameter setting of "Switch"

1.2.31 KNX Gateway Tuya-ZigBee > KNX Channel > Channel 1-10 > Channel 1

General	Device type	Switch/Dimming
General setting	Description (max 30char.)	Default Value: Switch
IP setting	Device online status reference by	Individual
KNX Channel	Time period for request [1..255]	10 min
General setting	Min. brightness value [0..50]	0 %
KNX Channel setting	Max. brightness value [51..100]	100 %
Channel 1-10		
Channel 1		

Parameter setting of "Switch/Dimming"

1.2.31 KNX Gateway Tuya-ZigBee > KNX Channel > Channel 1-10 > Channel 1

General	Device type	Curtain step/move
General setting	Description (max 30char.)	
IP setting	Device online status reference by	Individual
KNX Channel	Time period for request [1..255]	10 min
General setting		
KNX Channel setting		
Channel 1-10		
Channel 1		

Parameter setting of curtain

1.2.31 KNX Gateway Tuya-ZigBee > KNX Channel > Channel 1-10 > Channel 1

General	Device type	RGB dimming
General setting	Description (max 30char.)	
IP setting	Device online status reference by	Individual
KNX Channel	Time period for request [1..255]	10 min
General setting	Object datatype	<input checked="" type="radio"/> 1x3byte <input type="radio"/> 3x1byte
KNX Channel setting		
Channel 1-10		
Channel 1		

Parameter setting of "RGB dimming"

1.2.31 KNX Gateway Tuya-ZigBee > KNX Channel > Channel 1-10 > Channel 1

General	Device type	RGBW dimming
General setting	Description (max 30char.)	
IP setting	Device online status reference by	Individual
KNX Channel	Time period for request [1..255]	10 min
General setting	Object datatype	<input checked="" type="radio"/> 1x6byte <input type="radio"/> 4x1byte
KNX Channel setting		
Channel 1-10		
Channel 1		

Parameter setting of "RGBW dimming"

1.2.31 KNX Gateway Tuya-ZigBee > KNX Channel > Channel 1-10 > Channel 1

General	Device type	Color temperature
General setting	Description (max 30char.)	
IP setting	Device online status reference by	Individual
KNX Channel	Time period for request [1..255]	10 min
General setting	Min. color temperature [2000..7000]	2700 K
KNX Channel setting	Max. color temperature [2000..7000]	6500 K
Channel 1-10		
Channel 1		

Parameter setting of "Color temperature"

1.2.31 KNX Gateway Tuya-ZigBee > KNX Channel > Channel 1-10 > Channel 1

General	Device type	Value sender
General setting	Description (max 30char.)	
IP setting	Default Value:	
KNX Channel	Device online status reference by	Individual
General setting	Time period for request [1..255]	10 min
KNX Channel setting	Output object datatype for trigger	1bit[On/Off]
Channel 1-10	Output value	<input type="radio"/> OFF <input checked="" type="radio"/> ON
Channel 1		

Parametersetting of "Value sender"

1.2.31 KNX Gateway Tuya-ZigBee > KNX Channel > Channel 1-10 > Channel 1

General	Device type	Scene switch
General setting	Description (max 30char.)	
IP setting	Device online status reference by	Individual
KNX Channel	Time period for request [1..255]	10 min
General setting	Trigger scene No. from KNX	1
KNX Channel setting		
Channel 1-10		
Channel 1		

Fig.5.2.3.1 Parameter setting of basic function

**Parameter "Min. brightness value [0..50]%"**

**Parameter "Max. brightness value [51..100]%"**

These two parameters are visible when device type is selected "Switch/Dimming". Set the upper and lower limit threshold value of brightness.

The lower limit threshold value options: **0..50**; the upper limit threshold value options: **51..100**

**Parameter "Object datatype"**

This parameter is visible when device type is selected "RGB dimming" or "RGBW dimming". Set the object datatype of RGB or RGBW dimming.

Suitable for RGB type:

**1x3byte**

**3x1byte**

Suitable for RGBW type:

**1x6byte**

**4x1byte**

**Parameter “Min. color temperature[2000..7000]K”**

**Parameter “Max. color temperature[2000..7000]K”**

These two parameters are visible when device type is selected “Color temperature”. Set the upper and lower limit threshold value of color temperature. Options: **2000..7000**

When the minimum value and maximum value are set incorrect, The selected range is the whole range, for example the minimum value is larger than the maximum value. There is only one value when equal.

**For colour temperature, the Min. value must less than the Max., if not, if not, they can not be modified on ETS, and display red box warning, as shown as follow:**

Min. color temperature [2000..7000]	<input style="border: 2px solid red;" type="text" value="7000"/>	K
Max. color temperature [2000..7000]	<input type="text" value="6500"/>	K

**Parameter “Output object datatype for trigger”**

This parameter is visible when device type is selected “Value sender”. Set telegram type for sending to KNX bus when trigger calling command on the APP. Options:

**1bit[On/Off]**

**2bit[0..3]**

**1byte[0..100%]**

**1byte[0..255]**

**1byte[scene control]**

**2byte[Float]**

**2byte[0..65535]**

**Parameter “Output value”**

This parameter is visible when device type is selected “Value sender”, and corresponding datatype is selected. Set the telegram value for sending to KNX bus when trigger calling command on the APP. Options are according to the datatype:

**OFF ON(1bit) / 0..3(2bit) / 0..100(1byte) / 0..255(1byte) / 1..64(1byte) /  
-671 088.64..670 760.96(2byte) / 0..65535(2byte)**

## Parameter “Triggerscene No. from KNX”

This parameter is visible when device type is selected “Scene switch”. Set the scene calling command of KNX system to receive. Options:1..64

### 5.2.3.2. Parameter of air condition

This chapter explains the air condition function of KNX channel, including the basic and air conditioning control with swing. Parameters as follow are visible when “Air conditioner” or “Air conditioner(with swing)” is selected.

1.2.31 KNX Gateway Tuya-ZigBee > KNX Channel > Channel 1-10 > Channel 1

<ul style="list-style-type: none"> <li>— General</li> <li style="padding-left: 20px;">General setting</li> <li style="padding-left: 20px;">IP setting</li> <li>— KNX Channel</li> <li style="padding-left: 20px;">General setting</li> <li style="padding-left: 20px;">KNX Channel setting</li> <li>— Channel 1-10</li> <li style="padding-left: 20px; background-color: #e0e0e0;">Channel 1</li> <li style="padding-left: 20px;">Channel 2</li> <li style="padding-left: 20px;">Channel 3</li> <li style="padding-left: 20px;">Channel 4</li> <li style="padding-left: 20px;">Channel 5</li> <li style="padding-left: 20px;">Channel 6</li> <li style="padding-left: 20px;">Channel 7</li> <li style="padding-left: 20px;">Channel 8</li> <li style="padding-left: 20px;">Channel 9</li> <li style="padding-left: 20px;">Channel 10</li> <li style="padding-left: 20px;">Channel 11-20</li> <li style="padding-left: 20px;">Channel 21-30</li> <li style="padding-left: 20px;">Channel 31-40</li> <li style="padding-left: 20px;">Channel 41-50</li> <li style="padding-left: 20px;">Channel 51-60</li> <li style="padding-left: 20px;">Channel 61-70</li> <li style="padding-left: 20px;">Channel 71-80</li> </ul>	<p>Device type: <span style="border: 1px solid #ccc; padding: 2px;">Air conditioner</span></p> <p>Description (max 30char.): <input style="width: 100%;" type="text"/></p> <p>Device online status reference by: <span style="border: 1px solid #ccc; padding: 2px;">Individual</span></p> <p>Time period for request [1..255]: <span style="border: 1px solid #ccc; padding: 2px;">10</span> min</p> <p>Time period for request room temperature sensor [0..255]: <span style="border: 1px solid #ccc; padding: 2px;">10</span> min</p> <p>Min. setpoint temperature [16..32]: <span style="border: 1px solid #ccc; padding: 2px;">16</span> °C</p> <p>Max. setpoint temperature [16..32]: <span style="border: 1px solid #ccc; padding: 2px;">32</span> °C</p> <p><b>Control mode setting</b></p> <p>Auto mode: <input type="radio"/> Disable <input checked="" type="radio"/> Enable</p> <p>Output value for auto [0..255]: <span style="border: 1px solid #ccc; padding: 2px;">0</span></p> <p>Status value for auto [0..255]: <span style="border: 1px solid #ccc; padding: 2px;">0</span></p> <p>Heating mode: <input type="radio"/> Disable <input checked="" type="radio"/> Enable</p> <p>Output value for heating [0..255]: <span style="border: 1px solid #ccc; padding: 2px;">1</span></p> <p>Status value for heating [0..255]: <span style="border: 1px solid #ccc; padding: 2px;">1</span></p> <p>Cooling mode: <input type="radio"/> Disable <input checked="" type="radio"/> Enable</p> <p>Output value for cooling [0..255]: <span style="border: 1px solid #ccc; padding: 2px;">3</span></p> <p>Status value for cooling [0..255]: <span style="border: 1px solid #ccc; padding: 2px;">3</span></p> <p>Fan mode: <input type="radio"/> Disable <input checked="" type="radio"/> Enable</p> <p>Output value for fan [0..255]: <span style="border: 1px solid #ccc; padding: 2px;">9</span></p> <p>Status value for fan [0..255]: <span style="border: 1px solid #ccc; padding: 2px;">9</span></p> <p>Dehumidification mode: <input type="radio"/> Disable <input checked="" type="radio"/> Enable</p> <p>Output value for dehumidification [0..255]: <span style="border: 1px solid #ccc; padding: 2px;">14</span></p> <p>Status value for dehumidification [0..255]: <span style="border: 1px solid #ccc; padding: 2px;">14</span></p> <p>Object datatype of 1byte fan speed: <input type="radio"/> Fan stage (DPT_5.100) <input checked="" type="radio"/> Percentage (DPT_5.001)</p>
--	---

Fig.5.2.3.2(1) Parametersetting of air condition function

Channel 71-80	Object datatype of 1byte fan speed	<input type="radio"/> Fan stage (DPT_5.100) <input checked="" type="radio"/> Percentage (DPT_5.001)		
Channel 81-90		<b>Output value for fan speed</b>		
Channel 91-100		Output value for fan speed auto	<input type="text" value="0"/>	%
Channel 101-110		Output value for fan speed low	<input type="text" value="33"/>	%
Channel 111-120		Output value for fan speed medium	<input type="text" value="67"/>	%
Channel 121-130		Output value for fan speed high	<input type="text" value="100"/>	%
Channel 131-140		<b>Status feedback for fan speed</b>		
Channel 141-150		Status value for fan speed auto	<input type="text" value="0"/>	%
+ Zigbee Channel	Status value for fan speed low	<input type="text" value="33"/>	%	
+ Room temperature controller	Status value for fan speed medium	<input type="text" value="67"/>	%	
+ Ventilation controller	Status value for fan speed high	<input type="text" value="100"/>	%	

Fig.5.2.3.2[2] Parametersetting of air condition function

**Parameter “Time period for request room temperaturesensor [0...255]min”**

This parameter is for setting the time period for read request room temperature sensor.

Options: **0..255**

Send read request as default when the device voltage recovery.

**Parameter “Min./Max. setpoint temperature[16..32]°C”**

These two parameters are for setting the adjustable range of the setpoint temperature. If the setpoint temperature beyond the limited range, the will output the limited temperature. Options:

**16°C**

**17°C**

...

**32°C**

**For setpoint temperature, the Min. value must less than the Max., if not, it can not be modified on ETS.**

**Control mode setting**

**Parameter “Auto/Heating/Cooling/Fan/Dehumidificationmode”**

Corresponding mode setting is visible when these parameters are enabled.

**—Parameter “Output value for auto/heating/cooling/fan/dehumidification [0..255]”**

These parameters are visible when the modes are enabled. Set the output value for switching to each mode.

Options: **0..255**

——Parameter “Status value for auto/heating/cooling/fan/dehumidification [0..255]”

These parameters are visible when the modes are enabled. Set the status feedback value of each mode.

Options:0..255

Parameter “Object datatype of 1byte fan speed”

This parameter is for setting the object datatype of 1byte fan speed. Options:

**Fan stage (DPT 5.100)**

**Percentage (DPT 5.001)**

Output value for fan speed

——Parameter “Output value for fan speed auto/low/medium/high”

These parameters are for setting the output value for switching to each fan speed, support 4 fan speeds: auto, low, medium, high. Options are according to the object datatype of previous parameter: 0..255/0..100

Status feedback for fan speed

——Parameter “Status value for fan speed auto/low/medium/high”

These parameters are for setting the status feedback value of each fan speed, support 4 fan speeds: auto, low, medium, high. Options are according to the object datatype of previous parameter: 0..255/0..100

**Note: the out value and status value must meet the condition low<medium<high, if not, they can not be configured on ETS, and display red box warning(Only applicable to BTMO-TY/00.1(2)), as shown as follow:**

Output value for fan speed

Output value for fan speed auto	<input type="text" value="0"/>	%
Output value for fan speed low	<input type="text" value="33"/>	%
Output value for fan speed medium	<input type="text" value="67"/>	%
Output value for fan speed high	<input type="text" value="100"/>	%

5.2.3.3. Parameter of room temperature unit

This chapter explains the room temperature unit function of KNX channel, including the basic, control with control mode, and with fan speed. Parameters as follow are visible when “Room temperature unit”, “Room temperature unit(with operation mode)” or “Room temperature unit(with operation mode & fan speed)” is selected.

1.2.31 KNX Gateway Tuya-ZigBee > KNX Channel > Channel 1-10 > Channel 1

General	Device type	Room temperature unit(with operation mode & fan speed)
General setting	Description (max 30char.)	
IP setting	Device online status reference by	Individual
KNX Channel	Time period for request [1..255]	10 min
General setting	Time period for request room temperature sensor [0...255]	10 min
KNX Channel setting	Min. setpoint temperature [5..40]	5 °C
Channel 1-10	Max. setpoint temperature [5..40]	40 °C
Channel 1	Control mode	Heating
Channel 2	<b>Fan speed setting</b>	
Channel 3	Object datatype of 1byte fan speed	<input type="radio"/> Fan stage (DPT_5.100) <input checked="" type="radio"/> Percentage (DPT_5.001)
Channel 4	<b>Output value for fan speed</b>	
Channel 5	Output value for fan speed low	33 %
Channel 6	Output value for fan speed medium	67 %
Channel 7	Output value for fan speed high	100 %
Channel 8	<b>Status feedback for fan speed</b>	
Channel 9	Status value for fan speed low	33 %
Channel 10	Status value for fan speed medium	67 %
Channel 11-20	Status value for fan speed high	100 %
Channel 21-30	1 bit object function for fan speed	<input type="radio"/> Disable <input checked="" type="radio"/> Enable
Channel 31-40	1 bit object for fan speed off	<input type="radio"/> Disable <input checked="" type="radio"/> Enable
Channel 41-50		
Channel 51-60		

Fig.5.2.3.3 Parameter setting of room temperature unit

### Parameter “Time period for request room temperaturesensor [0...255]min”

This parameter is for setting the time period for read request room temperature sensor. Options: **0..255**

Send read request as default when the device voltage recovery.

### Parameter “Min./Max. setpoint temperature[5..40]°C”

These two parameters are for setting the adjustable range of the setpoint temperature. If the setpoint temperature beyond the limited range, the will output the limited temperature. Options:

- 5°C
- 6°C
- ...
- 40°C

For setpoint temperature, the Min. value must be less than the Max., if not, it cannot be modified on ETS.

### Parameter “Control mode”

This parameter is for setting temperature control mode, support 3 types: heating, cooling and heating/cooling.

Options:

- Heating
- Cooling
- Heating and Cooling

### Fan speed setting

This setting is visible when “Room temperature unit (with operation mode & fan speed)” is selected

### Parameter “Object datatype of 1byte fan speed”

This parameter is for setting the object datatype of 1byte fan speed. Options:

- Fan stage (DPT 5.100)
- Percentage (DPT 5.001)

### Output value for fan speed

#### —Parameter “Output value for fan speed low/medium/high”

These parameters are for setting the output value for switching to each fan speed, support 3 fan speeds: low, medium, high. Options are according to the object datatype of previous parameter: 0..255/0..100

### Status feedback for fan speed

#### —Parameter “Status value for fan speed low/medium/high”

These parameters are for setting the status feedback value of each fan speed, support 3 fan speeds: low, medium, high. Options are according to the object datatype of previous parameter: 0..255/0..100

**Note: the out value and status value must meet the condition low < medium < high, if not, they cannot be configured on ETS, and display red box warning, as shown as follow:**

Output value for fan speed low	68	%
Output value for fan speed medium	67	%
Output value for fan speed high	100	%



### Parameter “1 bit object function for fan speed”

This parameter is for setting whether to enable the object datatype of 1bit fan speed. When enabled, the 1 bit object of each fan speed is visible. When three objects value is 0, turn off the fan.

### —Parameter “1 bit object for fan speed off ”

This parameter is visible when previous parameter is enabled. Set whether to enable the object “1bit fan speed off” to visible.

### 5.2.3.4. Parameter of ventilation system

This chapter explains the ventilation system function of KNX channel. Parameters as follow are visible when “Ventilation system” is selected.

**1.2.31 KNX Gateway Tuya-ZigBee > KNX Channel > Channel 1-10 > Channel 1**

<ul style="list-style-type: none"> <li>— General               <ul style="list-style-type: none"> <li>General setting</li> <li>IP setting</li> </ul> </li> <li>— KNX Channel               <ul style="list-style-type: none"> <li>General setting</li> <li>KNX Channel setting</li> </ul> </li> <li>— Channel 1-10               <ul style="list-style-type: none"> <li style="background-color: #e0e0e0; padding: 2px;">Channel 1</li> <li>Channel 2</li> <li>Channel 3</li> <li>Channel 4</li> <li>Channel 5</li> <li>Channel 6</li> <li>Channel 7</li> <li>Channel 8</li> </ul> </li> </ul>	<table style="width: 100%; border-collapse: collapse;"> <tr> <td style="width: 30%;">Device type</td> <td style="width: 70%;">Ventilation system ▼</td> </tr> <tr> <td>Description (max 30char.)</td> <td><input type="text"/></td> </tr> <tr> <td>Device online status reference by</td> <td>Individual ▼</td> </tr> <tr> <td>Time period for request [1..255]</td> <td>10 min</td> </tr> <tr> <td>Default fan speed after ventilation on</td> <td>Low ▼</td> </tr> <tr> <td>Data type of fan speed</td> <td> <input type="radio"/> 1bit   <input checked="" type="radio"/> 1byte         </td> </tr> <tr> <td>Object datatype of 1byte fan speed</td> <td> <input type="radio"/> Fan stage (DPT_5.100)  <input checked="" type="radio"/> Percentage (DPT_5.001)         </td> </tr> <tr> <td colspan="2"><b>Output value for fan speed</b></td> </tr> <tr> <td>Output value for fan speed low</td> <td>33 %</td> </tr> <tr> <td>Output value for fan speed medium</td> <td>67 %</td> </tr> <tr> <td>Output value for fan speed high</td> <td>100 %</td> </tr> <tr> <td colspan="2"><b>Status feedback for fan speed</b></td> </tr> <tr> <td>Status value for fan speed low</td> <td>33 %</td> </tr> <tr> <td>Status value for fan speed medium</td> <td>67 %</td> </tr> <tr> <td>Status value for fan speed high</td> <td>100 %</td> </tr> </table>	Device type	Ventilation system ▼	Description (max 30char.)	<input type="text"/>	Device online status reference by	Individual ▼	Time period for request [1..255]	10 min	Default fan speed after ventilation on	Low ▼	Data type of fan speed	<input type="radio"/> 1bit <input checked="" type="radio"/> 1byte	Object datatype of 1byte fan speed	<input type="radio"/> Fan stage (DPT_5.100) <input checked="" type="radio"/> Percentage (DPT_5.001)	<b>Output value for fan speed</b>		Output value for fan speed low	33 %	Output value for fan speed medium	67 %	Output value for fan speed high	100 %	<b>Status feedback for fan speed</b>		Status value for fan speed low	33 %	Status value for fan speed medium	67 %	Status value for fan speed high	100 %
Device type	Ventilation system ▼																														
Description (max 30char.)	<input type="text"/>																														
Device online status reference by	Individual ▼																														
Time period for request [1..255]	10 min																														
Default fan speed after ventilation on	Low ▼																														
Data type of fan speed	<input type="radio"/> 1bit <input checked="" type="radio"/> 1byte																														
Object datatype of 1byte fan speed	<input type="radio"/> Fan stage (DPT_5.100) <input checked="" type="radio"/> Percentage (DPT_5.001)																														
<b>Output value for fan speed</b>																															
Output value for fan speed low	33 %																														
Output value for fan speed medium	67 %																														
Output value for fan speed high	100 %																														
<b>Status feedback for fan speed</b>																															
Status value for fan speed low	33 %																														
Status value for fan speed medium	67 %																														
Status value for fan speed high	100 %																														

Fig.5.2.3.4 Parameter setting of ventilation system

### Parameter “Default fan speed after ventilation on”

This parameter is for setting the initial fan speed after ventilation on. Switch status of ventilation is read from bus after download or reset, and default as off if can not read. Options:

- Low
- Medium
- High
- Last status

### Parameter “Data type of fan speed”

This parameter is for setting the data type of ventilation fan speed. Options:

- 1bit
- 1byte

#### ——Parameter “Object datatype of 1byte fan speed”

This parameter is visible when fan speed datatype is selected “1byte”. Set the datatype of 1byte fan speed object. Options:

- Fan stage (DPT 5.100)
- Percentage (DPT 5.001)

### Output value for fan speed

#### ——Parameter “Output value for fan speed low/medium/high”

These parameters are for setting the output value for switching to each fan speed, support 3 fan speeds: low, medium, high. Value=0 is fan speed off. Options are according to the object datatype of previous parameter: **0..255/0..100**

### Status feedback for fan speed

#### ——Parameter “Status value for fan speed low/medium/high”

These parameters are for setting the status feedback value of each fan speed, support 3 fan speeds: low, medium, high. Value=0 is fan speed off. Options are according to the object datatype of previous parameter: **0..255/0..100**

**Note: the out value and status value must meet the condition low<medium<high, if not, they can not be configured on ETS, and display red box warning, as shown as follow:**

Output value for fan speed low	68	%
Output value for fan speed medium	67	%
Output value for fan speed high	100	%

——Parameter “Object value of fan speed off/low/medium/high”

This parameter is visible when fan speed datatype is selected “1bit”. Set the control value for switching to each fan speed and the status feedback value. support 4 fan speeds: off, low, medium, high. Device will be update the fan speed display according to the feedback value. Options:

**Low=0,Medium=0,High=0**

**Low=1,Medium=0,High=0**

**Low=0,Medium=1,High=0**

**Low=1,Medium=1,High=0**

**Low=0,Medium=0,High=1**

**Low=1,Medium=0,High=1**

**Low=0,Medium=1,High=1**

**Low=1,Medium=1,High=1**

——Parameter “Delay between fan speed switch [0..100]\*50ms ”

This parameter is visible when fan speed datatype is selected “1bit”. Set the delay time between fan speeds switchover. Options: **0..100**

Turn off fan speed before switch the fan speed, and turn on it after the delay time. When delay time is set as 0, it will not turn off first then turn on, but switch to next fan speed directly.

### 5.2.3.5. Parameter of audio control

This chapter explains the audio control function of KNX channel, including the basic and audio control with power on/off. Parameters as follow are visible when “Audio control” or “Audio control (with on/off) ” is selected.

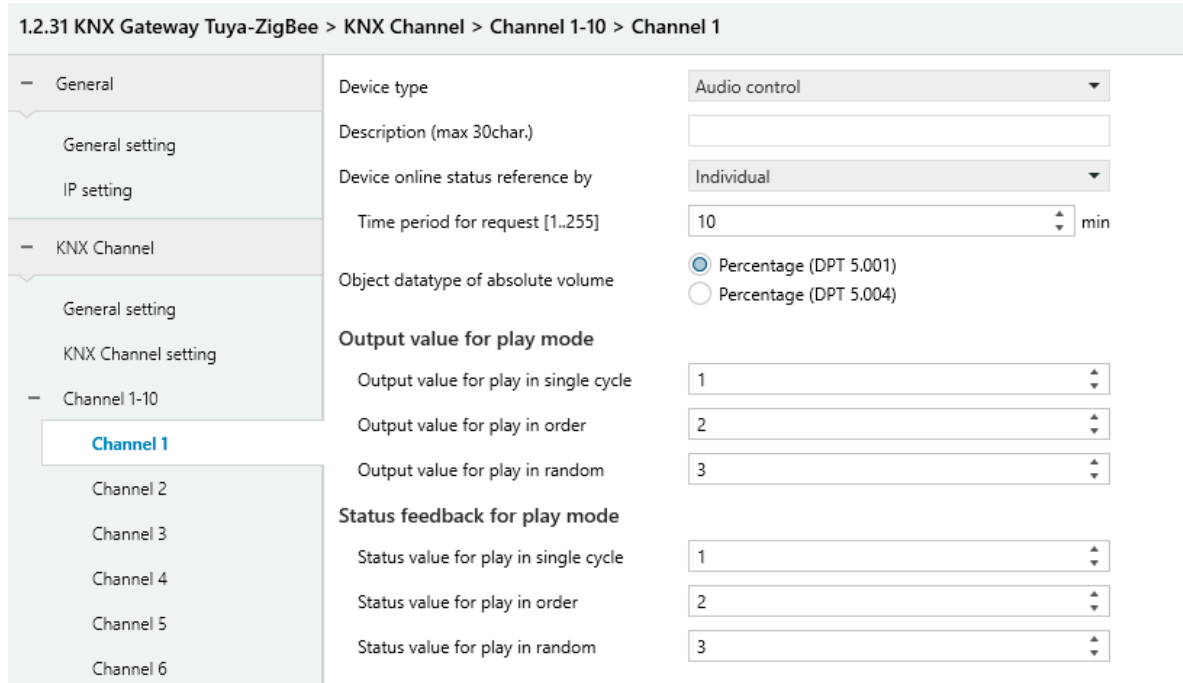

Fig.5.2.3.5 Parameter setting of audio control

#### Parameter “Object datatype of absolute volume”

This parameter is for setting the datatype of audio control object. Options:

**Percentage (DPT 5.001)**

**Percentage (DPT 5.004)**

#### Output value for play mode

##### ——Parameter “Output value for play in single cycle/order/random”

These parameters are for setting the control value of each mode, including single cycle/order/random play.

Options: **0..255**

#### Status feedback for play mode

##### ——Parameter “Status value for for play in single cycle/order/random”

These parameters are for setting the status value of each mode, including single cycle/order/random play. Device will be update the play mode display according to the feedback value. Options: **0..255**

### 5.2.3.6. Parameter of sensor function

This chapter explains the sensor function of KNX channel, including air quality sensor, presence sensor, motion sensor, brightness sensor, I/O sensor and etc.

1.2.31 KNX Gateway Tuya-ZigBee > KNX Channel > Channel 1-10 > Channel 1

General	Device type	Air quality sensor
General setting	Description (max 30char.)	
IP setting	Device online status reference by	Individual
KNX Channel	Time period for request [1..255]	10 min
General setting	Object datatype of PM2.5	<input type="radio"/> Value in ug/m3(DPT_7.001) <input checked="" type="radio"/> Float value in ug/m3(DPT_9.030)
KNX Channel setting	Object datatype of PM10	<input type="radio"/> Value in ug/m3(DPT_7.001) <input checked="" type="radio"/> Float value in ug/m3(DPT_9.030)
Channel 1-10	Object datatype of VOC	<input type="radio"/> Value in ug/m3(DPT_7.001) <input checked="" type="radio"/> Float value in ug/m3(DPT_9.030)
Channel 1	Object datatype of CO2	<input type="radio"/> Value in ppm (DPT 7.001) <input checked="" type="radio"/> Float value in ppm(DPT_9.008)
Channel 2		
Channel 3		

Parameter setting of "Air quality sensor"

1.2.31 KNX Gateway Tuya-ZigBee > KNX Channel > Channel 1-10 > Channel 1

General	Device type	CO2 sensor
General setting	Description (max 30char.)	
IP setting	Device online status reference by	Individual
KNX Channel	Time period for request [1..255]	10 min
General setting	Object datatype of CO2	<input type="radio"/> Value in ppm (DPT 7.001) <input checked="" type="radio"/> Float value in ppm(DPT_9.008)
KNX Channel setting		
Channel 1-10		
Channel 1		

Parameter setting of "CO2 sensor"

1.2.31 KNX Gateway Tuya-ZigBee > KNX Channel > Channel 1-10 > Channel 1

General	Device type	PM2.5 sensor
General setting	Description (max 30char.)	
IP setting	Device online status reference by	Individual
KNX Channel	Time period for request [1..255]	10 min
General setting	Object datatype of PM2.5	<input type="radio"/> Value in ug/m3(DPT_7.001) <input checked="" type="radio"/> Float value in ug/m3(DPT_9.030)
KNX Channel setting		
Channel 1-10		
Channel 1		

Parameter setting of "PM2.5 sensor"

1.2.31 KNX Gateway Tuya-ZigBee > KNX Channel > Channel 1-10 > Channel 1

General	Device type	VOC sensor
General setting	Description (max 30char.)	
IP setting	Device online status reference by	Individual
KNX Channel	Time period for request [1..255]	10 min
General setting	Object datatype of VOC	<input type="radio"/> Value in ug/m3(DPT_7.001) <input checked="" type="radio"/> Float value in ug/m3(DPT_9.030)
KNX Channel setting		
Channel 1-10		
Channel 1		

Parameter setting of "VOC sensor"

1.2.31 KNX Gateway Tuya-ZigBee > KNX Channel > Channel 1-10 > Channel 1

General	Device type	Presence sensor
General setting	Description (max 30char.)	
IP setting	Device online status reference by	Individual
KNX Channel	Time period for request [1..255]	10 min
General setting	Object datatype of brightness(lux)	<input type="radio"/> Value in lux (DPT 7.013) <input checked="" type="radio"/> Float value in lux (DPT 9.004)
KNX Channel setting		
Channel 1-10		
Channel 1		

Parameter setting of "Presence sensor"

1.2.31 KNX Gateway Tuya-ZigBee > KNX Channel > Channel 1-10 > Channel 1

General	Device type	Motion sensor
General setting	Description (max 30char.)	
IP setting	Device online status reference by	Individual
KNX Channel	Time period for request [1..255]	10 min
General setting		
KNX Channel setting		
Channel 1-10		
Channel 1		

Parameter setting of "Motion sensor"

1.2.31 KNX Gateway Tuya-ZigBee > KNX Channel > Channel 1-10 > Channel 1

General	Device type	Brightness sensor
General setting	Description (max 30char.)	
IP setting	Device online status reference by	Individual
KNX Channel	Time period for request [1..255]	10 min
General setting	Object datatype of brightness(lux)	<input type="radio"/> Value in lux (DPT 7.013) <input checked="" type="radio"/> Float value in lux (DPT 9.004)
KNX Channel setting		
Channel 1-10		
Channel 1		

Parameter setting of "Brightness sensor"

1.2.31 KNX Gateway Tuya-ZigBee > KNX Channel > Channel 1-10 > Channel 1

General	Device type	I/O signal
General setting	Description (max 30char.)	
IP setting	Device online status reference by	Individual
KNX Channel	Time period for request [1..255]	10 min
General setting		
KNX Channel setting		
Channel 1-10		
Channel 1		

Parameter setting of "I/O signal"

Fig.5.2.3.6 Parameter setting of sensor function

### **Parameter “Object datatype of PM2.5”**

This parameter is visible when device type is selected “Air quality sensor” or “PM2.5 sensor”. Set the object datatype of PM2.5. Options:

**Value in ug/m3 (DPT 7.001)**

**Float value in ug/m3 (DPT 9.030)**

### **Parameter “Object datatype of PM10”**

This parameter is visible when device type is selected “Air quality sensor”. Set the object datatype of PM10.

Options:

**Value in ug/m3 (DPT 7.001)**

**Float value in ug/m3 (DPT 9.030)**

### **Parameter “Object datatype of VOC”**

This parameter is visible when device type is selected “Air quality sensor” or “VOC sensor”. Set the object datatype of VOC. Options:

**Value in ug/m3 (DPT 7.001)**

**Float value in ug/m3 (DPT 9.030)**

### **Parameter “Object datatype of CO2”**

This parameter is visible when device type is selected “Air quality sensor” or “CO2 sensor”. Set the object datatype of CO2. Options:

**Value in ppm (DPT 7.001)**

**Float value in ppm (DPT 9.008)**

### **Parameter “Object datatype of brightness(lux)”**

This parameter is visible when device type is selected “Presence sensor” or “Brightness sensor”. Set the object datatype of brightness. Options:

**Value in lux (DPT 7.013)**

**Float value in lux (DPT 9.004)**

### 5.2.3.7. Parameter of current metering function

This chapter explains the current metering function of KNX channel. Parameters as follow are visible when device type is selected “Current metering”.

1.2.31 KNX Gateway Tuya-ZigBee > KNX Channel > Channel 1-10 > Channel 1

<ul style="list-style-type: none"> <li>- General           <ul style="list-style-type: none"> <li>General setting</li> <li>IP setting</li> </ul> </li> <li>- KNX Channel           <ul style="list-style-type: none"> <li>General setting</li> <li>KNX Channel setting</li> </ul> </li> <li>- Channel 1-10           <ul style="list-style-type: none"> <li><b>Channel 1</b></li> </ul> </li> </ul>	<p>Device type: <span style="border: 1px solid #ccc; padding: 2px;">Current metering</span></p> <p>Description (max 30char.): <input type="text"/></p> <p>Device online status reference by: <span style="border: 1px solid #ccc; padding: 2px;">Individual</span></p> <p>Time period for request [1..255]: <input style="width: 50px;" type="text" value="10"/> min</p> <p>Object datatype of current: <span style="border: 1px solid #ccc; padding: 2px;">Float value in mA (DPT 9.021)</span></p> <p>Object datatype of power:   <input checked="" type="radio"/> Float value in kW (DPT 9.024)   <input type="radio"/> Float value in W (DPT 14.056)</p>
---	--

Fig.5.2.3.7 Parameter setting of current metering function

#### Parameter “Object datatype of current”

This parameter is for setting the object datatype of current. Options:

- Value in mA (DPT 7.012)**
- Float value in mA (DPT 9.021)**
- Float value in A (DPT 14.019)**

#### Parameter “Object datatype of power”

This parameter is for setting the object datatype of power. Options:

- Float value in kW (DPT 9.024)**
- Float value in W (DPT 14.056)**



### 5.2.3.8. Parameter of energy metering function

This chapter explains the energy metering function of KNX channel. Parameters as follow are visible when device type is selected “Energy metering”.

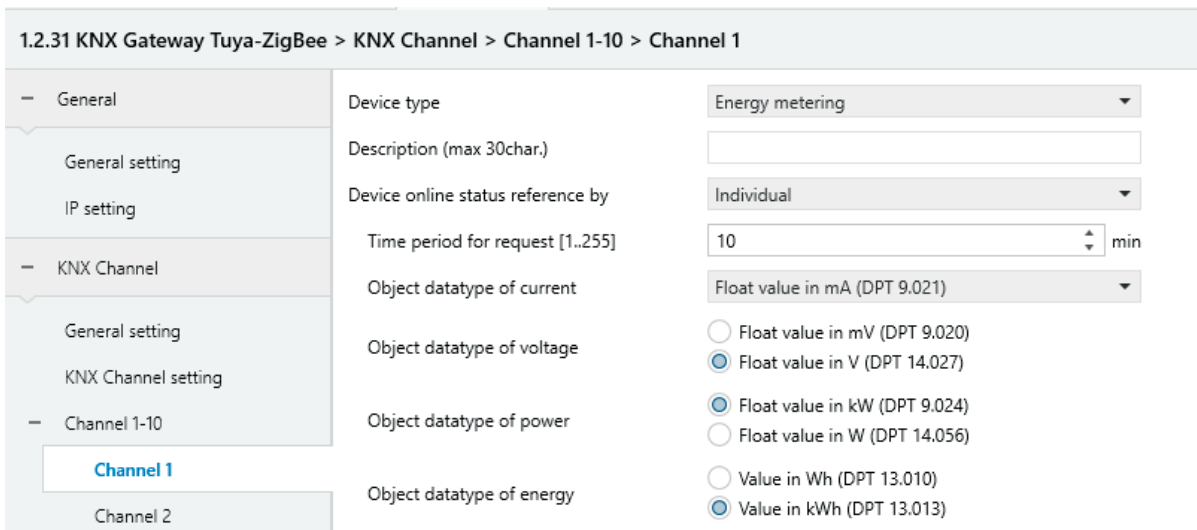

The screenshot shows the configuration page for '1.2.31 KNX Gateway Tuya-ZigBee > KNX Channel > Channel 1-10 > Channel 1'. The left sidebar has a tree view with 'Channel 1' selected. The main area contains the following settings:

- Device type:** Energy metering (dropdown menu)
- Description (max 30char.):** (text input field)
- Device online status reference by:** Individual (dropdown menu)
- Time period for request [1..255]:** 10 (spin box) min
- Object datatype of current:** Float value in mA (DPT 9.021) (dropdown menu)
- Object datatype of voltage:**
  - Float value in mV (DPT 9.020)
  - Float value in V (DPT 14.027)
- Object datatype of power:**
  - Float value in kW (DPT 9.024)
  - Float value in W (DPT 14.056)
- Object datatype of energy:**
  - Value in Wh (DPT 13.010)
  - Value in kWh (DPT 13.013)

Fig.5.2.3.8 Parameter setting of energy metering function

#### Parameter “Object datatype of current”

This parameter is for setting the object datatype of current. Options:

**Value in mA (DPT 7.012) Float**

**value in mA (DPT 9.021) Float**

**value in A (DPT 14.019)**

#### Parameter “Object datatype of voltage”

This parameter is for setting the object datatype of voltage. Options:

**Float value in mV (DPT 9.020)**

**Float value in V (DPT 14.027)**

#### Parameter “Object datatype of power”

This parameter is for setting the object datatype of power. Options:

**Float value in kW (DPT 9.024)**

**Float value in W (DPT 14.056)**

#### Parameter “Object datatype of energy”

This parameter is for setting the object datatype of energy. Options:

**Value in Wh (DPT 13.010)**

**Value in kWh (DPT 13.013)**

### 5.3. Parameter window “Zigbee Channel”

#### 5.3.1. Parameter window “Zigbee Channel setting”

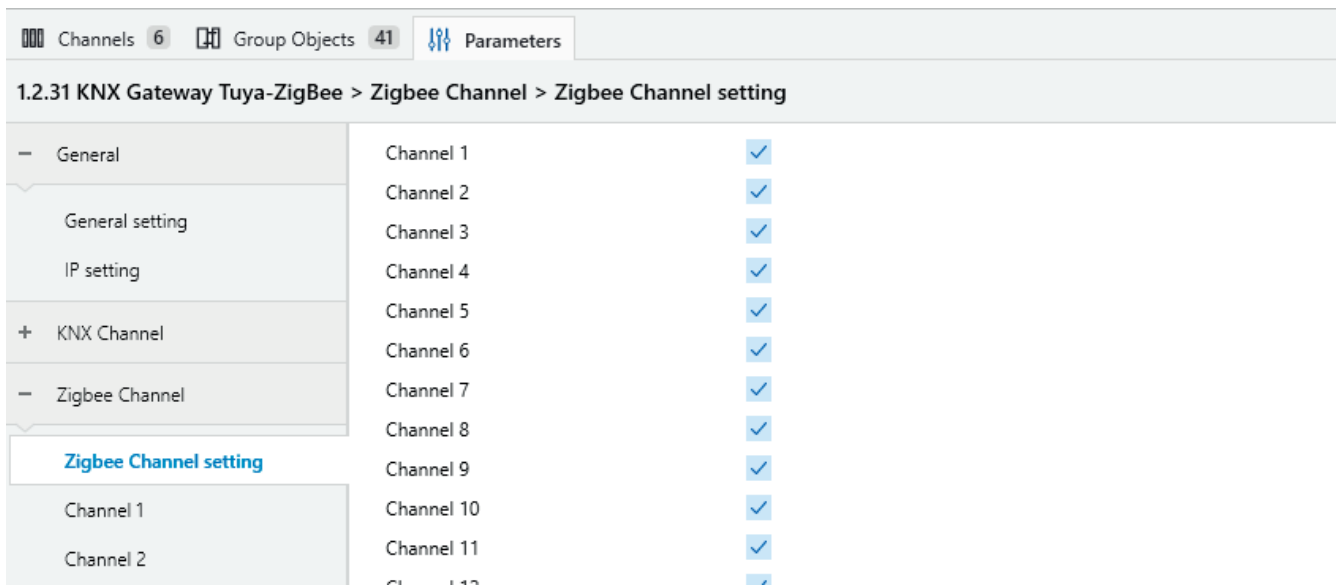

Fig.5.3.1 “Zigbee Channel setting” Parameter window

#### Parameter “Channel 1/2/3/...”

This parameter is for setting the Zigbee device setting. Display corresponding window when enabled. Up to support 32 channels.

### 5.3.2. Parameter window “Channel x” (x=1~32)

1.2.31 KNX Gateway Tuya-ZigBee > Zigbee Channel > Channel 1

- General		Description (max 24char.)	<input type="text"/>
General setting		Preset Mac address of zigbee device	<input type="text"/>
IP setting		<span style="background-color: #e0f2f7; padding: 2px;">i 8 hexadecimal data format, which can get from the property of ZigBee device on App</span>	
+ KNX Channel	Device type	Air quality sensor	
- Zigbee Channel		Object datatype of VOC	<input type="radio"/> Value in ug/m3(DPT_7.001) <input checked="" type="radio"/> Float value in ug/m3(DPT_9.030)
Zigbee Channel setting		Object datatype of CO2	<input type="radio"/> Value in ppm (DPT_7.001) <input checked="" type="radio"/> Float value in ppm(DPT_9.008)
Channel 1		Object datatype of formaldehyde	<input type="radio"/> Value in ug/m3(DPT_7.001) <input checked="" type="radio"/> Float value in ug/m3(DPT_9.030)
Channel 2			
+ KNX Channel	Device type	Temperature and humidity sensor	
+ KNX Channel	Device type	Brightness sensor	
- Zigbee Channel		Object datatype of brightness(lux)	<input type="radio"/> Value in lux (DPT_7.013) <input checked="" type="radio"/> Float value in lux (DPT_9.004)
+ KNX Channel	Device type	Gas sensor	
- Zigbee Channel		Object datatype of gas concentration	Float value in ug/m3 (DPT_9.030)
+ KNX Channel	Device type	I/O signal	
- Zigbee Channel		Object datatype of I/O signal	Switch (DPT_1.001)
+ KNX Channel	Device type	Switch	
- Zigbee Channel		Number of output	1
+ KNX Channel	Device type	Switch/Dimming	
+ KNX Channel	Device type	RGB dimming	
+ KNX Channel	Device type	Color temperature	
- Zigbee Channel		Min. color temperature [2000..7000]	2700 K
Zigbee Channel setting		Max. color temperature [2000..7000]	6500 K
+ KNX Channel	Device type	RGBCW	
- Zigbee Channel		Min. color temperature [2000..7000]	2700 K
Zigbee Channel setting		Max. color temperature [2000..7000]	6500 K
+ KNX Channel	Device type	Curtain position	
- Zigbee Channel		Number of output	<input checked="" type="radio"/> 1 <input type="radio"/> 2

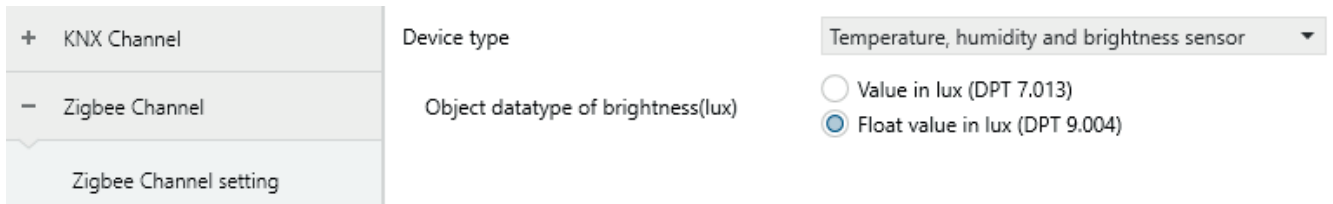



Fig.5.3.2 "Channel setting" Parameter window

### Parameter "Description (max 24char.)"

This parameter is for setting the name description for current channel device, up to input 24 characters.

### Parameter "Preset Mac address of zigbee device"

This parameter is for presetting MAC address of the current channel.

 8 hexadecimal data format, which can get from the property of ZigBee device on App

### Parameter "Device type"

This parameter is for setting the device type of the Zigbee channel. Options:

- Air quality sensor**
- Temperature and humidity sensor**
- Brightness sensor**
- Gas sensor**
- I/O signal**
- Switch**
- Switch/Dimming**
- RGB dimming**
- Color temperature**
- RGBCW**
- Curtain position**
- Temperature, humidity and brightness sensor**

### Parameter "Object datatype of VOC"

This parameter is visible when "Air quality sensor" is selected. Set the object datatype of VOC.

Options:

- Value in ug/m3 (DPT 7.001)**
- Float value in ug/m3 (DPT 9.030)**

**Parameter “Object datatype of CO2”**

This parameter is visible when “Air quality sensor” is selected. Set the object datatype of CO2.

Options:

**Value in ppm (DPT 7.001)**

**Float value in ppm (DPT 9.008)**

**Parameter “Object datatype of formaldehyde”**

This parameter is visible when “Air quality sensor” is selected. Set the object datatype of formaldehyde.

Options:

**Value in ppm (DPT 7.001)**

**Float value in ppm (DPT 9.008)**

**Parameter “Object datatype of brightness(lux)”**

This parameter is visible when “Brightness sensor” or “Temperature, humidity and brightness sensor” is selected. Set the object datatype of brightness. Options:

**Value in lux (DPT 7.013)**

**Float value in lux (DPT 9.004)**

**Parameter “Object datatype of gas concentration”**

This parameter is visible when “Gas sensor” is selected. Set the object datatype of gas concentration.

Options:

**Value in ug/m3 (DPT 7.001)**

**Float value in ppm (DPT 9.008)**

**Float value in ug/m3 (DPT 9.030)**

**Parameter “Object datatype of I/O signal”**

This parameter is visible when “I/O signal” is selected. Set the object datatype of I/O signal.

Options:

**Switch (DPT 1.001)**

**Boolean (DPT 1.002)**

**Alarm (DPT 1.005)**

**Occupancy (DPT 1.018)**

**Window/door (DPT 1.019)**

**Parameter “Number of output”**

This parameter is visible when “Switch” or “Curtain position” is selected. Set the output channel of Switch or Curtain.

Options for switch output: **1 / 2 / 3**

Options for curtain output: **1 / 2**

**Parameter “Min. color temperature[2000..7000]K”**

**Parameter “Max. color temperature[2000..7000]K”**

These two parameters are visible when “Color temperature” or “RGBCW” is selected. Set the upper and lower limit threshold value of color temperature. Options: **2000..7000**

When the minimum value and maximum value are set incorrect, The selected range is the whole range, for example the minimum value is larger than the maximum value. There is only one value when equal.

**For colour temperature, the Min. value must less than the Max., if not, if not, they can not be modified on ETS, and display red box warning, as shown as follow:**

Min. color temperature [2000..7000]	<input type="text" value="7000"/>	K
Max. color temperature [2000..7000]	<input type="text" value="6500"/>	K

## 5.4. Parameter window “Room temperature controller”

### 5.4.1. Parameter window “RTC Channel setting”

1.2.31 KNX Gateway Tuya-ZigBee > Room temperature controller > RTC Channel setting

+ General	Room temperature controller 1	<input checked="" type="checkbox"/>
+ KNX Channel	Room temperature controller 2	<input checked="" type="checkbox"/>
+ Zigbee Channel	Room temperature controller 3	<input checked="" type="checkbox"/>
- Room temperature controller	Room temperature controller 4	<input checked="" type="checkbox"/>
	Room temperature controller 5	<input checked="" type="checkbox"/>
	Room temperature controller 6	<input checked="" type="checkbox"/>
	Room temperature controller 7	<input checked="" type="checkbox"/>
	Room temperature controller 8	<input checked="" type="checkbox"/>
	Room temperature controller 9	<input checked="" type="checkbox"/>
	Room temperature controller 10	<input checked="" type="checkbox"/>

Fig.5.4.1 “RTC Channel setting” Parameterwindow

### Parameter “Room temperature controller 1/2/3/...”

This parameter is for setting whether to enable the setting interface of RTC device, display corresponding interface. Up to enable 10 channels.

### 5.4.2. Parameter window “RTC x”(x=1~10)

1.2.31 KNX Gateway Tuya-ZigBee > Room temperature controller > RTC 1

+ General	Time period for request room temperature sensor [0...255]	10 min
+ KNX Channel	Control value after temp. error[0..100] (if 2-point control, set value '0'=0, set value '>0'=1)	0 %
+ Zigbee Channel		
- Room temperature controller	Room temperature control mode	Heating and Cooling
	Heating/Cooling switchover	<input checked="" type="radio"/> Via object <input type="radio"/> Automatic changeover
	Heating/Cooling status after download	<input type="radio"/> Heating <input checked="" type="radio"/> Cooling
	Heating/Cooling status after power on	As before power off
	Room temperature control system	<input type="radio"/> 2 pipes system <input checked="" type="radio"/> 4 pipes system
	Operation mode	<input type="radio"/> Disable <input checked="" type="radio"/> Enable
	Controller status after download	Comfort mode
	Controller status after power on	As before power off

Fig.5.4.2(1) “RTC 1” parameter window

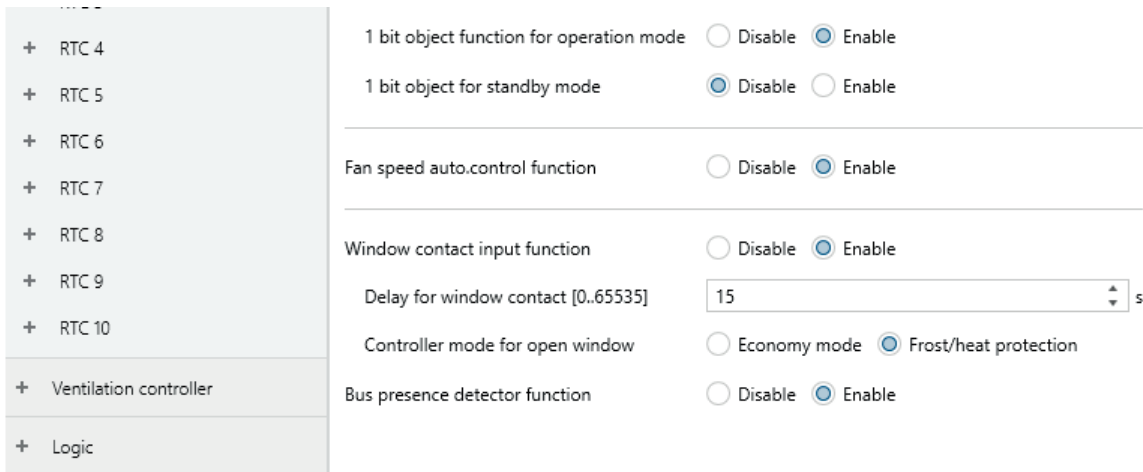

Fig.5.4.2[2] "RTC 1" parameter window

### Parameter "Time period for request room temperature sensor [0...255]min"

This parameter is for setting the time period for read request external temperature sensor. Send read request to external temperature sensor after the device voltage recovery or finish programming. Options: **0..255**

### Parameter "Control value after temp. error[0..100]%(if 2-point control, set value '0'=0, set value '>0'=1)"

This parameter is for setting the control value when temperature error occur. Options: **0..100**

If 2-Point control, then the parameter value is 0, as well as the control value; if the parameter value is more than 0, then the control value will be 1.

### Parameter "Room temperature control mode"

This parameter is for setting RTC control mode, support 3 types: heating, cooling and heating/cooling.

Options:

- Heating**
- Cooling**
- Heating and Cooling**

Heating and Cooling: heating and cooling are available. At the same time, four parameters as follow are visible.

#### ——Parameter "Heating/Cooling switchover"

This parameter is for setting the switchover way of Heating/Cooling. Options:

- Via object**
- Automatic changeover**

#### ——Parameter "Heating/Cooling status after download"

This parameter is for setting the heating/cooling control mode of device after download.

Options:



**Heating**

**Cooling**

**—— Parameter “Heating/Cooling status after power on”**

This parameter is for setting the heating/cooling control mode of device after voltage recovery.  
Options:

**Heating**

**Cooling**

**As before power off**

As before voltage failure: When the device is reset after power on, the control mode will recover as before voltage failure or restart. If it is the first time the device is used or a newly enabled function page, the control mode after the device is started is in an uncertain state, and it needs to be manually selected at this time.

**—— Parameter “Room temperature control system”**

This parameter is for setting the type of RTC control system, that is, pipe types of fan coil water inlet/outlet. Options:

**2 pipes system**

**4 pipes system**

2 pipes system: Shares an inlet and outlet pipe for heating and cooling, that is, both hot and cold water are controlled by a valve.

4 pipes system: Has its own inlet and outlet pipes for heating and cooling, and two valves are needed to control the entry and exit of hot water and cold water respectively.

**Parameter “Operation mode”**

This parameter is for setting whether to enable RTC operation mode. Options:

**Disable**

**Enable**

When enable, support 4 modes: comfort, standby, economy and frost/heat protection. Support datatype of 1bit and 1byte, and preset a operation mode when download and voltage recovery.

**Four parameters as follow are visible when RTC operation mode enabled.**

**—— Parameter “Controller status after download”**

This parameter is for setting the operation mode after download. Options:

**Standby mode**

**Comfort mode**

**Economy mode**

— Parameter “Controller status after power on”

This parameter is for setting the operation mode after voltage recovery. Options:

**Standby mode**

**Comfort mode**

**Economy mode**

**Frost/heat protection**

**As before power off**

— Parameter “1 bit object function for operation mode”

This parameter is for setting whether to enable 1 bit objects of operation mode are visible. Options:

**Disable**

**Enable**

— Parameter “1 bit object for standby mode”

This parameter is visible when previous parameter enabled. Set whether to enable 1 bit object of standby mode is visible. Options:

**Disable**

**Enable**

**Three parameters as follow are visible when RTC operation mode disabled.**

— Parameter “Initial setpoint temperature(°C)”

This parameter is for setting the initial value of setpoint temperature. Options:

**10.0**

**10.5**

**...**

**35.0**

When initial setpoint temperature is less than the min. setpoint temperature, display following warning:

 The setpoint is less than minimum,so minimum will regard as setpoint in fact

When initial setpoint temperature is greater than the max. setpoint temperature, display following warning:

 The setpoint is greater than maximum,so maximum will regard as setpoint in fact

### **Automatic H/C mode changeover dead zone**

#### **— Parameter “Upper/Lowerdead zone”**

These two parameters are visible when control mode “Heating and Cooling” is selected, and “Automatic changeover” is selected. Setting the dead zone range of auto switchover heating/cooling. Options:

**0.5°C**

**1.0°C**

**...**

**10°C**

Under heating control, when the actual temperature(T) greater than or equal to the setpoint temperature+ the upper dead zone, then mode heating switch to cooling;

Under cooling control, when the actual temperature(T) less than or equal to the setpoint temperature+ the upper dead zone, then mode cooling switch to heating.

#### **Parameter “Fanspeed auto.control function”**

This parameter is for setting whether to enable fan auto control interface is visible. Options:

**Disable**

**Enable**

#### **Parameter “Window contact input function”**

This parameter is visible when operation mode enabled. Set whether to link to window contact status.

Options:

**Disable**

**Enable**

#### **— Parameter “Delay for window contact [0..65535]s”**

This parameter is visible when operation mode and window contact input function are enabled. Set the delay time to window contact detection. That is, when receive a telegram “window open”, the controller will regard that as a valid signal and execute the behaviour after this delay time. Options:

**0..65535**

#### **— Parameter “Controllermode for open window”**

This parameter is visible when operation mode and window contact input function are enabled. If window status is open, perform corresponding operation according to configuration. Options:

### **Economy mode**

#### **Frost/heat protection**

Other control telegram receiving will be record during window is open and performed after receiving the telegram "Close window". If there is no telegram receiving when window is open, keep the current mode.

#### **Parameter "Bus presence detector function"**

This parameter is visible when operation mode enabled. Set whether to link to bus presence detector status. Options:

**Disable**

**Enable**

If presence is detected, enter the comfort mode, and it will be restored to original mode after leaving. If there is a telegram/manual operation to adjust the mode during the period, the telegram is logged in the background, and it will be exited comfort mode and restored to the mode after leaving. If there is no telegram receiving during timing, return to original mode. (If receive the presence status cyclically, comfort mode can not be re-triggered, and only can be after leaving.)

#### **Parameter "Min./Max. setpoint temperature[5..40]°C"**

These parameters are visible when operation mode disabled. Set to limit the adjustable range of the setpoint temperature. If the setpoint temperature beyond the limited range, the will output the limited temperature. Options:

**5°C**

**6°C**

**...**

**40°C**

These parameters are display below the parameters settings interface "Setpoint" when enable operation mode.

**For setpoint temperature, the Min. value must less than the Max., if not, it can not be modified on ETS.**

### 5.4.2.1. Parameter window “Setpoint”

1.2.31 KNX Gateway Tuya-ZigBee > Room temperature controller > RTC 1 > Setpoint

+ General	<b>Heating</b>		
+ KNX Channel	Setpoint temperature in comfort mode [5..40]	21	°C
+ Zigbee Channel	Setpoint temperature in standby mode [5..40]	19	°C
- Room temperature controller	Setpoint temperature in economy mode [5..40]	17	°C
RTC Channel setting	Setpoint temperature in frost protection mode [5..40]	7	°C
- RTC 1	<b>Cooling</b>		
Setpoint	Setpoint temperature in comfort mode [5..40]	23	°C
Heating control	Setpoint temperature in standby mode [5..40]	25	°C
Cooling control	Setpoint temperature in economy mode [5..40]	27	°C
Fan	Setpoint temperature in heat protection mode [5..40]	35	°C
+ RTC 2	<div style="border: 1px solid #00aaff; padding: 5px;"> <p><b>i</b> Note: The heating setpoint must be always less than the cooling setpoint</p> </div>		
+ RTC 3	Min. setpoint temperature [5..40]	5	°C
+ RTC 4	Max. setpoint temperature [5..40]	40	°C
+ RTC 5			
+ RTC 6			
+ RTC 7			
+ RTC 8			

Fig.5.4.2.1 “Setpoint” parameter window

Parameters of this window are visible when RTC operation mode enabled, display according to control mode. The temperature setpoint value uses the way of absolute adjustment.

**Parameter “Setpoint temperature in comfort mode [5...40]°C”**

**Parameter “Setpoint temperature in standby mode [5...40]°C”**

**Parameter “Setpoint temperature in economy mode [5...40]°C”**

**Parameter “Setpoint temperature in frost protection mode [5...40]°C”(for heating)**

**Parameter “Setpoint temperature in heat protection mode [5...40]°C”(for cooling)**

These parameters are for setting the temperature setpoint value of each mode. Options:

**5°C**

**6°C**

**...**

**40°C**

**i** Note: The heating setpoint must be always less than the cooling setpoint

**When “Heating and Cooling” is selected, whether it is manual changeover, bus changeover or automatic changeover, the heating setpoint value must be less than or equal to the cooling of the same operation mode, if not, it can not be configured on ETS.**

1. When the ambient temperature is higher than the setpoint temperature of current mode, it is changed to cooling mode; When the ambient temperature is lower than the setpoint temperature of current mode, it is changed to heating mode.

2. In the same operation mode, the setpoint temperature difference between cooling and heating remains constant, whether it is written on the bus or adjusted on the panel. That is, when adjust the setpoint temperature, it need to update cooling and heating setpoint temperature of current operation mode at the same time.

3. When the bus is received setpoint temperature, it is still necessary to limit the value according to the high and low thresholds, that is heating and cooling temperature neither can not be lower than the min., or can not be higher than the max.. If parameters configuration of ETS is not met the condition, it will be noted warnings:

When the setpoint temperature of comfort/standby/economy mode is less than the min. setpoint temperature, display following warning:

 The setpoint is less than minimum, so minimum will regard as setpoint in fact

When the setpoint temperature of comfort/standby/economy mode is greater than the max. setpoint temperature, display following warning:

 The setpoint is greater than maximum, so maximum will regard as setpoint in fact

**Note: for protection mode, the setpoint temperature is only configured via ETS, and not limited with the min./max. value. When the received setpoint value from bus is different from the ETS configuration, the value is not updated and returned to the current setpoint temperature, to update synchronously to other devices on the bus.**

### 5.4.2.2. Parameter window “Heating/Cooling control”

1.2.31 KNX Gateway Tuya-ZigBee > Room temperature controller > RTC 1 > Heating control

General	Type of heating control	Switching on/off(use 2-point control)
General setting	Invert control value	<input checked="" type="radio"/> No <input type="radio"/> Yes
IP setting	Lower Hysteresis [0...200]*0.1	10 °C
	Upper Hysteresis [0...200]*0.1	10 °C
+ KNX Channel	Cyclically send control value [0...255]	10 min
+ Zigbee Channel		
- Room temperature controller		
RTC Channel setting		
- RTC 1		

Parameter setting of “Switching on/off(use 2-point control)”

1.2.31 KNX Gateway Tuya-ZigBee > Room temperature controller > RTC 1 > Cooling control

General	Type of cooling control	Switching PWM(use PI control)
General setting	Invert control value	<input checked="" type="radio"/> No <input type="radio"/> Yes
IP setting	PWM cycle time [1...255]	15 min
+ KNX Channel	Cooling speed	Cooling ceiling (5K/240min)
+ Zigbee Channel	Cyclically send control value [0...255]	10 min
- Room temperature controller		
RTC Channel setting		
- RTC 1		
Setpoint		

Parameter setting of “Switching PWM(use PI control)”

1.2.31 KNX Gateway Tuya-ZigBee > Room temperature controller > RTC 1 > Heating control

General	Type of heating control	Continuous control(use PI control)
General setting	Invert control value	<input checked="" type="radio"/> No <input type="radio"/> Yes
IP setting	Heating speed	User defined
+ KNX Channel	Proportional range [10..100]*0.1	40 °C
+ Zigbee Channel	Reset time [0..255]	150 min
- Room temperature controller	Send control value on change by [0...100,0=inactive]	4 %
RTC Channel setting	Cyclically send control value [0...255]	10 min
- RTC 1		
Setpoint		
Heating control		

Parameter setting of “Continuous control(use PI control)”

Fig.5.4.2.2(1) “Heating/Cooling control” parameter window

Parameters of this window display according to control mode and control system(2 pipe or 4pipe).

#### **Parameter “Type of heating/cooling control”**

This parameter is for setting the type of heating/cooling control. Different control types are suitable for controlling different temperature controllers. Options:

**Switching on/off(use 2-point control)**

**Switching PWM(use PI control)**

**Continuous control(use PI control)**

#### **Parameter “Invert control value”**

This parameter is for setting whether to invert control value or normal sending control value, so that the control value will be suitable for the valve type. Options:

**No**

**Yes**

Yes: Sending the control value to the bus through objects after inverting the control value.

#### **Two parameters as follow are suitable for 2 point control:**

——Parameter “LowerHysteresis [0...200]\*0.1°C”

——Parameter “UpperHysteresis [0...200]\*0.1°C”

These two parameters are for setting the lower/upper hysteresis temperature in HVAC heating or cooling. Options: **0..200**

**Under heating control,**

**When the actual temperature(T) > the setting temperature + the upper hysteresis temperature, then will stop heating;**

**When the actual temperature(T) < the setting temperature - the lower hysteresis temperature, then will start heating.**

For example, the lower hysteresis temperature is 1°, the upper hysteresis temperature is 2°, the setting temperature is 22°, if T is higher than 24°, then it will stop heating; if T is lower than 21°, then it will start heating; if T is between 21~24°, then it will maintain the previous status.



**Under the cooling control,**

**When the actual temperature (T) < the setting temperature -the lower hysteresis temperature, then will stop cooling;**

**When the actual temperature (T) > the setting temperature +the upper hysteresis temperature, then will start cooling.**

For example, the lower hysteresis temperature is 1°, the upper hysteresis temperature is 2°, the setting temperature is 26°, if T is lower than 25°, then it will stop cooling; if T is lower than 28°, then it will start cooling; if T is between 28~25°, then it will maintain the previous status.

**2-point control mode is a very simple control mode. When adopting this control mode, it is necessary to set the upper hysteresis temperature and the lower hysteresis temperature through parameters. When setting the hysteresis temperature, the following effects need to be considered:**

1. When hysteresis interval is small, the temperature range will be small, however, frequent sending of control value will bring large load to the bus;
2. When hysteresis interval is large, the switch switching frequency will be low, but it is easy to cause uncomfortable temperature change.

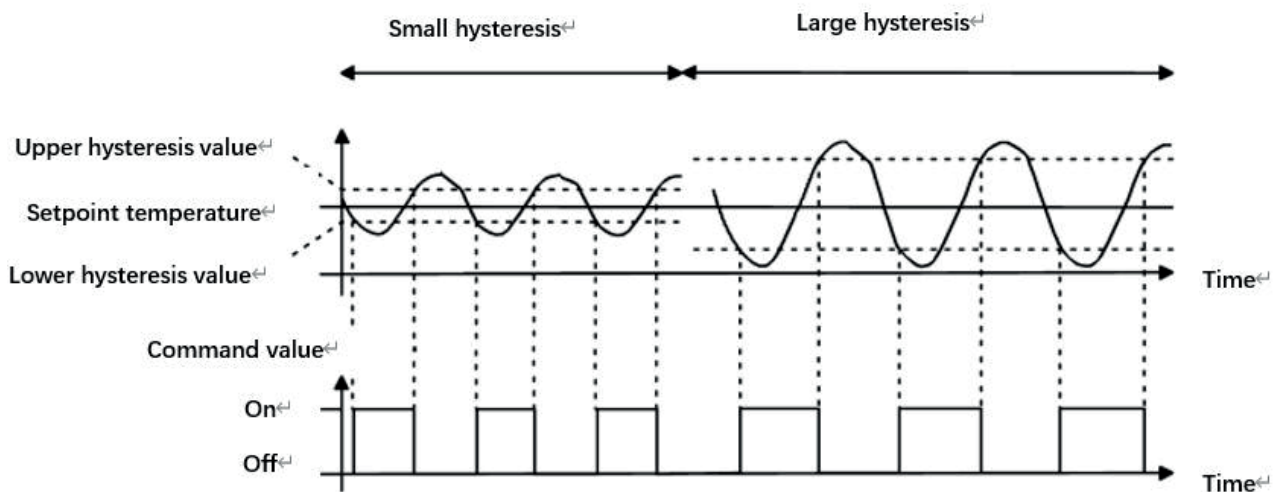

Fig.5.4.2.2(2) Effects of hysteresis on control value switch action(heating) under 2-point control mode

## Two parameters as follow are suitable for PI control:

— Parameter “Heating speed ”

— Parameter “Cooling speed”

These two parameters are for setting the responding speed of heating or cooling PI controller. Different responding speeds are suitable for different environments.

Options:

**Hot water heating (5K/150min)**

**Underfloor heating (5K/240 min)**

**Electrical heating (4K/100min)**

**Split unit (4K/90min)**

**Fan coil unit (4K/90min)**

**User defined**

Options:

**Cooling ceiling (5K/240min)**

**Split unit (4K/90min)**

**Fan coil unit(4K/90min)**

**User defined**

— Parameter “Proportional range [10..100]\*0.1°C”(P value)

— Parameter “Reset time [0..255]min”(I value)

These two parameters are visible when “User defined” is selected. Set the PI value of PI controller.

Options: **10..100 (P value)**

Options: **0..255 (I value)**

— Parameter “PWM cycle time [1...255]min”

This parameter is only visible when the control type is “Switching PWM(use PI control)”. Set the period of the control object cycle to send the switch value, the object sends the switch value according to the duty cycle of the control value. For example, if the set period is 10 min and the control value is 80%, then the object will send an open telegram for 8 min. If the control value is changed, the time duty

ratio of the on/ off telegram of the object will also change, but the period is still the time of parameter setting.

Options: **1..255**

The PI values of “Switching PWM (use PI control)” and “Continuous control (use PI control)” are the same, only different in control objects, the control object of “Continuous control” output PI value(1byte) directly, while the control value of “Switching PWM” output a “on/off ” telegram according to the duty cycle of the control value.

**——Parameter “Send control value on change by [0...100,0=inactive]”**

This parameter is visible when control type is “Continuous control (use PI control)”, for setting the changing value of the control value to be sent to the bus. Options: **0..100, 0=inactive**

**Parameter “Cyclically send control value [0...255]min”**

This parameter is for setting the period for cyclically sending the control value to the bus. Options: **0..255**

**In PI control mode, the predefined control parameters of each PI controller in heating or cooling system are recommended as follows:**

**(1) Heating**

Heating type	P value	I value (integration time)	Recommended PI control type	Recommended PWM period
Hot water Heating	5K	150min	Continuous/PWM	15min
Underfloor heating	5K	240min	PWM	15-20min
Electrical heating	4K	100min	PWM	10-15min
Split unit	4K	90min	PWM	10-15min
Fan coil unit	4K	90min	Continuous	--

### (2) Cooling

Cooling type	P value	I value (integration time)	Recommended PI control type	Recommended PWM period
Cooling ceiling	5K	240min	PWM	15-20min
Split unit	4K	90min	PWM	10-15min
Fan coil unit	4K	90min	Continuous	--

### (3) User defined

When the parameter "Heating/Cooling speed" is set to "User defined", the parameter value of P (scale factor) and I (integration time) can be set through the parameter. When adjusting the parameters, refer to the fixed PI value mentioned in the above table. Even if the control parameters are adjusted slightly, the control behavior will be significantly different.

In addition, the integration time should be set properly. If the integration time is too long, the adjustment will be slow, and the oscillation will not be obvious; if the integration time is too small, the adjustment will be fast, but the oscillation will occur. 0 means the integral term is not used.

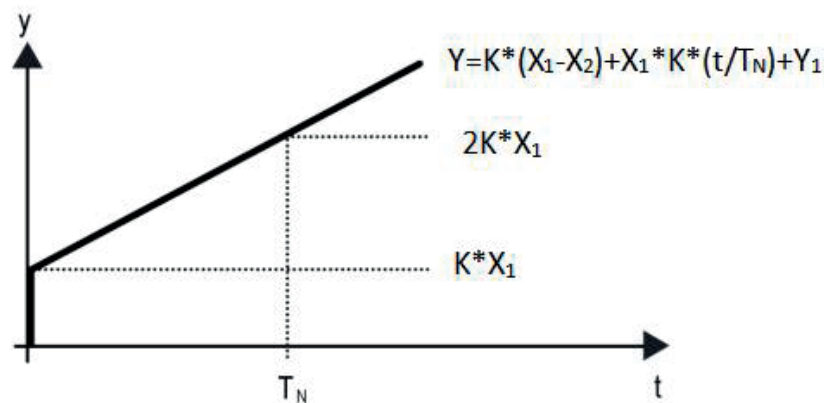

Fig.5.4.3 (7) control value of PI control mode

Y: control value

Y1: last control value

X1: temperature deviation = set temperature - actual temperature

X2: last temperature deviation = set temperature - actual temperature

$T_N$ : integration time

K: scale factor (the scale factor is not zero)

PI control algorithm:  $Y = K \cdot (X_1 - X_2) + X_1 \cdot K \cdot t / T_N + Y_1$

When the integration time is set to zero, the PI control algorithm is:  $Y = K (X1-X2) + Y2$

### Setting and influence of user-defined parameters:

Parameter setting	Effect
K: If the scale range is too small	Quick adjustment, and overshoot will occur
K: If the scale range is too big	Slow adjustment, but no overshoot
T <sub>N</sub> : If the integration time is too short	Quick adjustment, but there will be oscillation
T <sub>N</sub> : If the integration time is too long	Slow adjustment, no obvious oscillation

#### 5.4.2.3. Parameter window “Fan”

1.2.31 KNX Gateway Tuya-ZigBee > Room temperature controller > RTC 1 > Fan

- General
- General setting
- IP setting
- + KNX Channel
- + Zigbee Channel
- Room temperature controller
- RTC Channel setting
- RTC 1
  - Setpoint
  - Heating control
  - Cooling control
  - Fan
- + RTC 2
- + RTC 3
- + RTC 4
- + RTC 5
- + RTC 6
- + RTC 7
- + RTC 8
- + RTC 9

Auto. operation on object value  Auto=1/Man.=0  Auto=0/Man.=1

**Fan speed output setting**

Object datatype of 1byte fan speed  Fan stage (DPT\_5.100)  Percentage (DPT\_5.001)

Output value for fan speed low  %

Output value for fan speed medium  %

Output value for fan speed high  %

---

**Fan speed output setting**

Condition setting for using 2-point control

Temperature difference speed OFF<-->low [1..200]\*0.1  °C

Temperature difference speed low<-->medium [1..200]\*0.1  °C

Temperature difference speed medium<-->high [1..200]\*0.1  °C

Hysteresis temperature difference in [0..50]\*0.1  °C

Condition setting for using PI control

Threshold value speed OFF<-->low [1..255]

Threshold value speed low<-->medium [1..255]

Threshold value speed medium<-->high [1..255]

Hysteresis threshold value in +/-[0..50]

Minimum time in fan speed [0..65535]  s

Fig.5.4.2.3 “Fan” parameter window

Parameters of this window are visible when fan auto control enabled.

### Parameter “Auto. operation on object value”

This parameter is for setting the telegram value to activate automatic operation. Options:

**Auto=1/Man.=0**

**Auto=0/Man.=1**

Auto=1/Man.=0: When the object “Fan automatic operation” receives the telegram value “0”, activate the automatic operation, when receive “1”, exit the automatic operation.

Auto=0/Man.=1: When the object “Fan automatic operation” receives the telegram value “1”, activate the automatic operation, when receive “0”, exit the automatic operation.

**After power-on, automatic operation is not activated by default.**

### Fan speed output setting

#### Parameter “Object datatype of 1byte fan speed”

This parameter is for setting the object datatype of 1 byte fan speed. Options:

**Fan stage (DPT 5.100)**

**Percentage (DPT 5.001)**

#### —Parameter “Output value for fan speed low/medium/high”

These three parameters are for setting the value sent for each fan speed switchover. Fan speed off when value is 0. Options according to fan object datatype: **1..255 /1..100**

**Note: the out value and status value must meet the condition low<medium<high, if not, they can not be configured on ETS, and display red box warning, as shown as follow:**

Output value for fan speed low	<input type="text" value="68"/>	%
Output value for fan speed medium	<input type="text" value="67"/>	%
Output value for fan speed high	<input type="text" value="100"/>	%

### Fan speed control setting

#### Condition setting for using 2-point control

Under 2-point control, controller will decide the fan power on/off or fan speed according to the temperature difference between the actual temperature and setpoint temperature.

Cooling: Temperature difference = actual temperature - setpoint temperature;

Heating: Temperature difference = setpoint temperature - actual temperature.

**Parameter “Temperature difference speed OFF<-->low[1..200] \*0.1°C”**

This parameter is for setting the temperature difference between off-fan and low-level fan speeds.

Options: **1..200**

If the temperature difference is greater than or equal to this setting temperature difference, low-level fan speed will start running; if less than this setting temperature difference, the fan will be turned off.

**Parameter “Temperature difference speed low<-->medium[1..200]\*0.1°C”**

Define the temperature difference for switching the fan speed to medium fan speed, if the control value is greater than or equal to this setting temperature difference, the medium fan speed will start running.

Options: **1..200**

**Parameter “Temperature difference speed medium<-->high[1..200]\*0.1°C”**

Define the temperature difference for switching the fan speed to high fan speed, if the control value is greater than or equal to this setting temperature difference, the high fan speed will start running. Options: **1..200**

**Parameter “Hysteresis temperature difference in [0..50] \*0.1°C”**

This parameter is for setting the hysteresis value of the temperature difference, which can avoid the unnecessary action of the fan when the control value fluctuates near the temperature difference.

Options: **0..50**

If value is 0, no hysteresis. Fan switch to speed once control value greater than temperature difference;

Suppose that hysteresis value is 0.5° and the temperature difference is 1°, then the upper limit temperature difference 1.5° (Temperature difference+Hysteresis value) and the lower limit temperature difference 0.5° (Temperature difference-Hysteresis value). When the control value is between 0.5° ~1.5°, fan action will not be caused, and the previous status will still be maintained. Only less than 0.5° or greater than or equal to 1.5° will change the running status of the fan.

## Condition setting for using PI control

Under PI control, control value is PI operated within program, controller will power on/off fan or switch fan speed according to the threshold range of the control values.

### Parameter “Threshold value speed OFF<-->low[1..255]”

Define threshold value for off-fan and low-level fan speeds, options: **1..255**

If the control value is greater than or equal to this setting threshold value, low-level fan speed will start running; if the control value is less than this setting threshold value, the fan will be turned off.

### Parameter “Threshold value speed low<-->medium[1..255]”

Define the threshold value for switching the fan speed to medium fan speed, if the control value is greater than or equal to this setting threshold, the medium fan speed will start running. Options: **1..255**

### Parameter “Threshold value speed medium<-->high[1..255]”

Define the threshold for switching the fan speed to high fan speed, if the control value is greater than or equal to this setting threshold, the high fan speed will start running. Options: **1..255**

**Tip: The controller evaluates the threshold in ascending order.**

**First check → OFF <-> low fan speed threshold → low fan speed <-> medium fan speed → medium fan speed <-> high fan speed.**

**The correctness of functional execution is guaranteed only in this case:**

**The threshold of OFF <-> low fan speed is lower than that of low fan speed <-> medium fan speed, and the threshold of low fan speed <-> medium fan speed is lower than that of medium fan speed <-> high fan speed.**

### Parameter “Hysteresis threshold value in +/-[0..50]”

This parameter is for setting the hysteresis value of the threshold value, which can avoid the unnecessary action of the fan when the control value fluctuates near the threshold. Options: **0..50**

If value is 0, no hysteresis. Fan switch to speed once control value greater than threshold value;

Suppose that hysteresis value is 10 and the threshold is 50, then the upper limit threshold 60 (Threshold value+Hysteresis value) and the lower limit threshold 40 (Threshold value-Hysteresis value). When the control value is between 40 ~60, fan action will not be caused, and the previous status will still be maintained. Only less than 40 or greater than or equal to 60 will change the running status of the fan.

### Parameter “Minimum time in fan speed [0..65535]s”

Defines the residence time of the fan from the current fan speed to a higher fan speed or lower fan speed, that is, the minimum time for a fan speed operation.



If you need to switch to another fan speed, you need to wait for this period of time before switching.

If the current fan speed has been running long enough, the fan speed can be changed quickly.

Options: **0..65535**

0: there is no minimum running time, but the delay switching time of fan speed still needs to be considered.

**Note: The residence time for this parameter setting is only enabled in Auto mode.**

## 5.5. Parameter window “Ventilation controller”

### 5.5.1. Parameter window “Control setting”

1.2.31 KNX Gateway Tuya-ZigBee > Ventilation controller > Controller setting

<ul style="list-style-type: none"> <li>– General</li> <li style="padding-left: 20px;">General setting</li> <li style="padding-left: 20px;">IP setting</li> <li>+ KNX Channel</li> <li>+ Zigbee Channel</li> <li>+ Room temperature controller</li> <li>– Ventilation controller</li> <li style="background-color: #e0f0ff; padding: 2px 5px;">Controller setting</li> <li>+ Logic</li> </ul>	<p>Ventilation controller <input checked="" type="checkbox"/></p> <p>Auto.operation on object value <input checked="" type="radio"/> Auto=1/Man.=0 <input type="radio"/> Auto=0/Man.=1</p> <p>State of Auto.operation after startup <input checked="" type="radio"/> Disable <input type="radio"/> Enable</p> <p><b>Fan speed output setting</b></p> <p>Data type of fan speed <input type="radio"/> 1bit <input checked="" type="radio"/> 1byte</p> <p>Object datatype of 1byte fan speed <input type="radio"/> Fan stage (DPT_5.100) <input checked="" type="radio"/> Percentage (DPT_5.001)</p> <p>Output value for fan speed low <input style="width: 100px;" type="text" value="33"/> %</p> <p>Output value for fan speed medium <input style="width: 100px;" type="text" value="67"/> %</p> <p>Output value for fan speed high <input style="width: 100px;" type="text" value="100"/> %</p> <p><b>Fan speed control setting</b></p> <p>Control value reference from <input style="width: 100px;" type="text" value="PM2.5"/></p> <p>Object datatype of PM2.5 <input checked="" type="radio"/> Value in ug/m3(DPT_7.001) <input type="radio"/> Float value in ug/m3(DPT_9.030)</p> <p>Time period for request control value [0...255] <input style="width: 100px;" type="text" value="10"/> min</p> <p>The fan speed status when the control value error <input style="width: 100px;" type="text" value="Off"/></p> <p>Threshold value OFF&lt;--&gt;speed low [1...999] <input style="width: 100px;" type="text" value="35"/></p> <p>Threshold value speed low&lt;--&gt;medium [1...999] <input style="width: 100px;" type="text" value="75"/></p> <p>Threshold value speed medium&lt;--&gt;high [1...999] <input style="width: 100px;" type="text" value="115"/></p> <p>Hysteresis value is threshold value in +/- [10...30] <input style="width: 100px;" type="text" value="10"/></p> <p>Minimum time in fan speed [0...65535] <input style="width: 100px;" type="text" value="10"/> s</p>
--	---

Fig.5.5.1 “Control setting” parameter window

### **Parameter “Ventilation controller”**

This parameter is for setting whether to enable ventilation controller, to realize the automatic control of the fan speed, and link the fan speed to the detection value of PM2.5 or CO2, VOC. Parameters as follow are visible when enabled.

### **Parameter “Auto. operation on object value”**

This parameter is for setting the telegram value to activate automatic operation. Options:

**Auto=1/Man.=0**

**Auto=0/Man.=1**

Auto=1/Man.=0: When the object “Fan automatic operation” receives the telegram value “0”, activate the automatic operation, when receive “1”, exit the automatic operation.

Auto=0/Man.=1: When the object “Fan automatic operation” receives the telegram value “1”, activate the automatic operation, when receive “0”, exit the automatic operation.

**After power-on, automatic operation is not activated by default.**

### **Parameter “State of Auto.operation after startup”**

This parameter is for setting whether to enable state of Auto.operation after startup the device. Options:

**Disable**

**Enable**

### **Fan speed output setting**

#### **Parameter “Data type of fan speed”**

This parameter is for setting the data type of fan speed. Options:

**1bit**

**1byte**

#### **——Parameter “Object datatype of 1byte fan speed”**

This parameter is visible when “1byte” is selected. Set the object datatype of 1byte fan speed. Options:

**Fan stage (DPT 5.100)**

**Percentage (DPT 5.001)**

**——Parameter “Output value for fan speed low/medium/high”**

This parameter is visible when “1byte” is selected. Set the value sent for each fan speed switchover. Fan speed off when value is 0. Options according to fan object datatype: **1..255 /1..100**

**Note: the out value and status value must meet the condition low<medium<high,if not, they can not be configured on ETS, and display red box warning,as shown as follow:**

Output value for fan speed low	68	%
Output value for fan speed medium	67	%
Output value for fan speed high	100	%

**——Parameter “Object value of fan speed off/low/medium/high”**

This parameter is visible when 1bit” is selected. Set the value sent for each fan speed, sent by three 1 bit objects at the same time. Options:

**Low=0,Medium=0,High=0**

**Low=1,Medium=0,High=0**

**Low=0,Medium=1,High=0**

**Low=1,Medium=1,High=0**

**Low=0,Medium=0,High=1**

**Low=1,Medium=0,High=1**

**Low=0,Medium=1,High=1**

**Low=1,Medium=1,High=1**

**——Parameter “Delay between fan speed switch [0..100]\*50ms”**

This parameter is visible when 1bit” is selected. Set the delay time between fan speed switchover, and consider it according to the fan technical characters. Options: **0..100**

Turn off fan speed before switch the fan speed, and turn on it after the delay time. When delay time is set as 0, it will not turn off first then turn on, but switch to next fan speed directly.

## Fan speed control setting

### Parameter “Control value reference from”

This parameter is for setting the reference of control value under automatic operation. Options:

**PM2.5**

**CO2**

**VOC**

### ——Parameter “Object datatype of PM2.5/VOC”

These parameters are for setting the datatype of PM2.5/VOC. Datatype determines object type, select it according to the docking PM2.5 or VOC sensor data type. Options:

**Value in ug/m3(DPT 7.001)**

**Float value in ug/m3(DPT 9.030)**

DPT\_7.001: Suitable for integrated value.

DPT\_9.030: Suitable for float value.

### ——Parameter “Object datatype of CO2”

This parameter is for setting the datatype of CO2. Datatype determines object type, select it according to the docking CO2 sensor data type. Options:

**Value in ppm(DPT 7.001)**

**Float value in ppm(DPT 9.008)**

DPT\_7.001: Suitable for integrated value.

DPT\_9.008: Suitable for float value.

### Parameter “Time period for request control value [0...255]min”

This parameter is for setting the time period for device to send a control value read request to external sensor after bus recovery or finish programming (**After stabilization time 2min, then read**).

Options: **0..255**

### Parameter “The fan speed status when the control value error”

This parameter is for setting the default fan speed of ventilation system when control value is error.

Options:

**Off**

**Low**

**Medium**

**High**

**Parameter “Threshold value speed OFF<-->low[1..999]/ [1...4000]”**

Define threshold value for off-fan and low-levelfan speeds, options: **1..999/1..4000**

If the control value is greater than or equal to this setting threshold value, low-level fan speed will start running; if the control value is less than this setting threshold value, the fan will be turned off. **Parameter**

**“Threshold value speed low<-->medium[1..999]/ [1...4000]”**

Define the threshold value for switching the fan speed to medium fan speed, if the control value is greater than or equal to this setting threshold, the medium fan speed will start running. Options:

**1..999/1..4000**

**Parameter “Threshold value speed medium<-->high[1..999]/ [1...4000]”**

Define the threshold for switching the fan speed to high fan speed, if the control value is greater than or equal to this setting threshold, the high fan speed will start running. Options: **1..999/1..4000**

**Tip: The controller evaluates the threshold in ascending order.**

**First check →OFF <->low fan speed threshold →low fan speed <->medium fan speed →medium fan speed <->high fan speed.**

**The correctness of functional execution is guaranteed only in this case:**

**The threshold of OFF <-> low fan speed is lower than that of low fan speed <-> medium fan speed, and the threshold of low fan speed <-> medium fan speed is lower than that of medium fan speed <-> high fan speed.**

**Parameter “Hysteresis threshold value in +/- [10...30]/[100..400]”**

This parameter is for setting the hysteresis value of the threshold value, which can avoid the unnecessary action of the fan when the control value fluctuates near the threshold. Options:

**10..30/100..400**

For example, the control type is CO2, the Hysteresis value is 100 and the threshold is 450, then the upper limit threshold 550 (Threshold value+Hysteresis value) and the lower limit threshold 350 (Threshold value-Hysteresis value). When the control value is between 350 ~550, fan action will not be caused, and the previous status will still be maintained. Only less than 350 or greater than or equal to

550 will change the running status of the fan. As shown in the following figure:

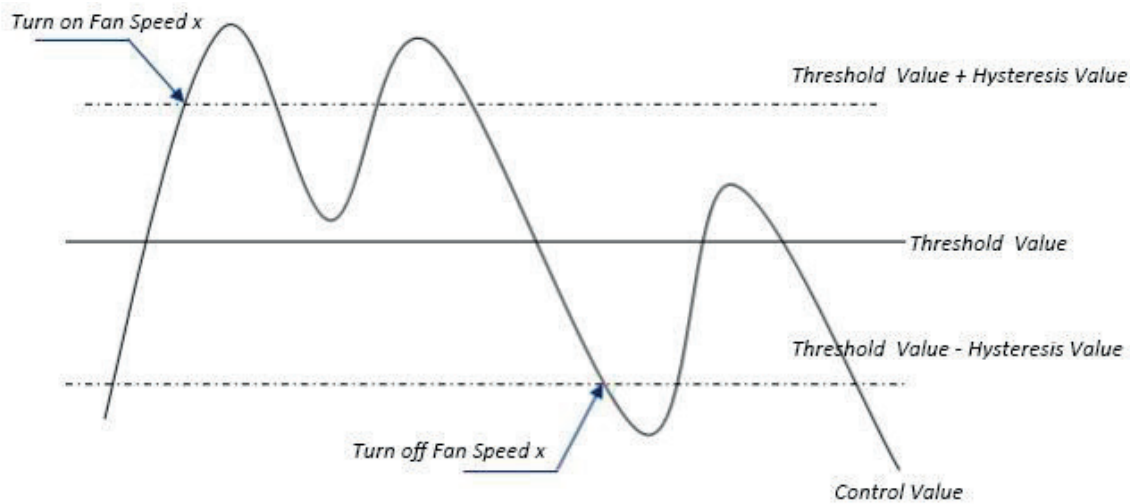

**Note:**

When hysteresis is enabled, if the threshold overlap occurs, fan action is specified as follows:

- 1) Hysteresis determines the control point where Fan speed conversion occurs;
- 2) If Fan speed conversion occurs, new fan speed is determined by control value and threshold value, irrespective of hysteresis.

value, irrespective of hysteresis.

For example (1):

Take PM2.5 as an example

OFF  $\leftrightarrow$  Low fan speed threshold value is 35

Low fan speed  $\leftrightarrow$  Medium fan speed threshold value is 55

Medium fan speed  $\leftrightarrow$  High fan speed threshold value is 75

Hysteresis value is 25

The fan speed of the fan turbine increases from OFF:

Fan OFF status will change at a control value of 60 ( $\geq 25+35$ ), and new fan speed will be the mid-fan speed (because 60 is between 55 and 75, irrespective of hysteresis at this time), so the low fan speed is ignored;

The behavior of fan speed when descending from a high fan speed:

The high fan speed will change at a control value of 50 ( $< 75-25$ ), and new fan speed will be low fan speed (because 50 is between 35 and 55, irrespective of hysteresis), so the fan speed is ignored.

**For example(2):**

**Take PM2.5 as an example**

**OFF <-> Low fan speed threshold value is 20**

**Low fan speed <-> Medium fan speed threshold value is 40**

**Medium fan speed <-> High fan speed threshold value is 70**

**Hysteresis value is 10**

**When fan speed is increasing from OFF:**

**The OFF status will be turned when the control value is 30 ( $\geq 20+10$ )**

**When the control value 41 is received, the new speed will be at medium (because the hysteresis is ignored when the value 41 is between 40 and 70), therefore the low speed is ignored.**

**When the control value 39 is received, the new speed will be at low (because the hysteresis is ignored when the value 39 is between 20 and 40)**

**When Fan Speed decreasing from high:**

**The high speed will be turned when the control value is 60 ( $< 70-10$ )**

**When the control value 39 is received, the new speed will be at low (because the hysteresis is ignored when the value 39 is between 20 and 40), therefore the medium speed is ignored.**

**3) When the control value is 0, the fan will be off at any circumstances.**

#### **Parameter “Minimum time in fan speed [0..65535]s”**

Defines the residence time of the fan from the current fan speed to a higher fan speed or lower fan speed, that is, the minimum time for a fan speed operation. Options: **0..65535**

If you need to switch to another fan speed, you need to wait for this period of time before switching.

If the current fan speed has been running long enough, the fan speed can be changed quickly.

0: there is no minimum running time, but the delay switching time of fan speed still needs to be considered.

**Note: The residence time for this parameter setting is only enabled in Auto mode.**

## 5.6. Parameter window “Logic”

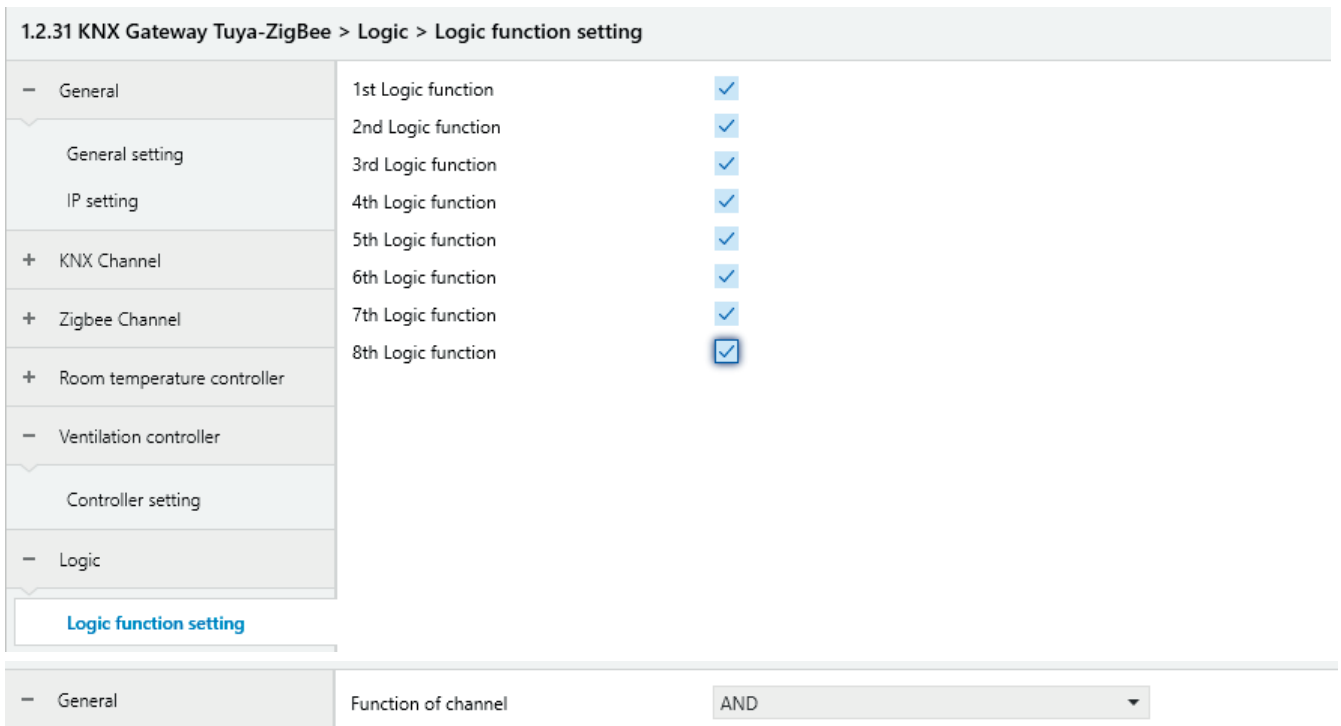

Fig.5.6 “Logic function setting” Parameter window

### Parameter “1st/2nd/3rd... Logic function”

This parameter is for setting the setting interface of logic function, display corresponding logic function page when select. Up to enable 8 logic functions.

### Parameter “Function of channel”

This parameter is for setting the logic function of the channel. Options:

**AND**

**OR**

**XOR**

**Gate forwarding**

**Threshold comparator**

**Format convert**

**Gate function**

**Delay function**

**Staircase lighting**

AND/OR/XOR: as the parameter is similar to the communication object (only the logic algorithm is different), the following parameters taking one options for example.



### 5.6.1. Parameter window “AND/OR/XOR”

1.2.31 KNX Gateway Tuya-ZigBee > Logic > 1st Logic

General	Function of channel	AND
General setting	Input a	Disconnected
IP setting	Default value	<input checked="" type="radio"/> 0 <input type="radio"/> 1
KNX Channel	Input b	Disconnected
Zigbee Channel	Default value	<input checked="" type="radio"/> 0 <input type="radio"/> 1
Room temperature controller	Input c	Disconnected
Ventilation controller	Default value	<input checked="" type="radio"/> 0 <input type="radio"/> 1
Controller setting	Input d	Disconnected
Logic	Default value	<input checked="" type="radio"/> 0 <input type="radio"/> 1
Logic function setting	Input e	Disconnected
1st Logic	Default value	<input checked="" type="radio"/> 0 <input type="radio"/> 1
2nd Logic	Input f	Disconnected
3rd Logic	Default value	<input checked="" type="radio"/> 0 <input type="radio"/> 1
4th Logic	Input g	Disconnected
5th Logic	Default value	<input checked="" type="radio"/> 0 <input type="radio"/> 1
6th Logic	Input h	Disconnected
7th Logic	Default value	<input checked="" type="radio"/> 0 <input type="radio"/> 1
8th Logic	Result is inverted	<input checked="" type="radio"/> No <input type="radio"/> Yes
	Read input object value after bus voltage recovery	<input checked="" type="radio"/> No <input type="radio"/> Yes
	Output send when	<input checked="" type="radio"/> Receiving a new telegram <input type="radio"/> Every change of output object
	Send delay time: Base	None
	Factor: 1..255	1

Fig.5.6.1 “AND/OR/XOR” parameter window

#### Parameter “Input a/b/c/d/e/f/g/h”

This parameter is for setting whether input x to calculate, whether to normally calculate or inverted calculate. Options:

**Disconnected**

**Normal**

**Inverted**

Disconnected: not to calculate;

Normal: to directly calculate the input value;

Inverted: invert the input value, then to calculate. **Note: not to invert the initiate value.**

### —Parameter “Default value”

This parameter is for setting the initial value of logic input x. Options:

**0**  
**1**

### Parameter “Result is inverted”

This parameter is for setting whether to invert the logic calculation result. Options:

**No**  
**Yes**

No: output directly;

Yes: output after inverting.

### Parameter “Read input object value after bus voltage recovery”

This parameter is for setting whether to send the read request to the logic input object after device voltage recovery or finish programming. Options:

**No**  
**Yes**

### Parameter “Output send when”

This parameter is for setting the condition of sending logic result. Options:

**Receiving a new telegram**  
**Every change of output object**

Receiving a new telegram: every time the object received a new input value will the logic result be sent to the bus;

Every change of output object: only when logic result has changed will it be sent to the bus.

**Tip: when in the first time to logic calculate, the logic result will be sent even if it has no change.**

### Parameter “Send delay time”

**Base:**            **None**  
                     **0.1s**  
                     **1s**  
                     ...  
                     **10s**  
                     **25s**  
**Factor:**        **1..255**

This parameter is for setting the delay time for sending the logic calculation result to the bus. Delay time = Base × Factor, if option “None” of Base is selected, then there is no delay.

### 5.6.2. Parameter window “Gate forwarding”

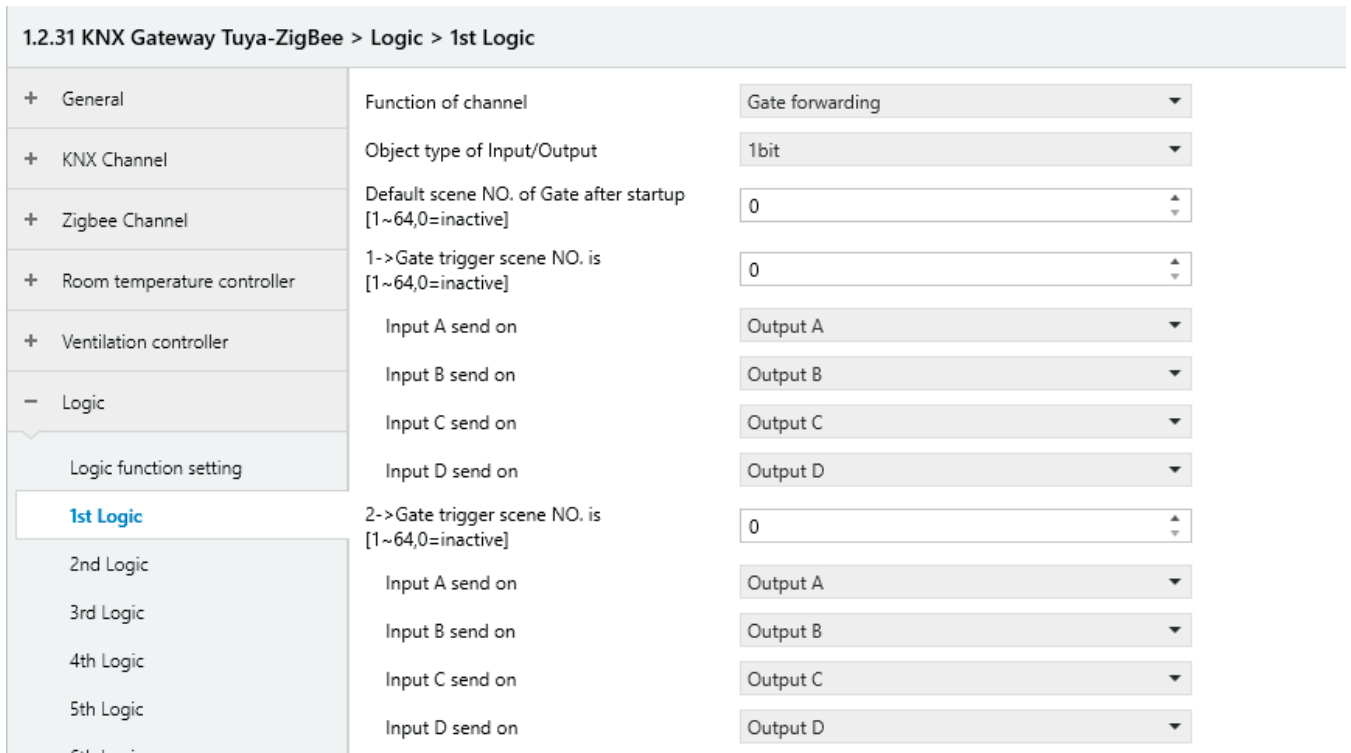

Fig.5.6.2 “Gate forwarding” parameter window

This parameter is for setting the object type of input/output. Options:

**1bit**

**4bit**

**1byte**

#### Parameter “Default scene NO. of Gate after startup [1~64,0=inactive]”

This parameter is for setting the initial scene where logical gate forwarding can be performed by default after device starts, which needs to be configured in the parameters. Options : **1..64, 0=inactive**

**Note: gate scene is recommended to be selected before operating, or it will enable the initiate scene by default.**

#### Parameter “z->Gate trigger scene NO. is [1~64,0=inactive]”(z=1~8)

This parameter is for setting scene number of logic gate forwarding. Up to 8 trigger scene number can be set for each logic. Options: **1..64, 0=inactive**

### —Parameter “Input A/B/C/D send on”

This parameter is for setting the output of input X (X=A/B/C/D) after gate forwarding. Options:

**Output A**

**Output B**

...

**Output B,C,D**

According to the options, one input can be forwarded into one or more outputs, the output value is the same as the input value.

### 5.6.3. Parameter window “Threshold comparator”

1.2.31 KNX Gateway Tuya-ZigBee > Logic > 1st Logic		
+ General	Function of channel	Threshold comparator
+ KNX Channel	Threshold value data type	1byte
+ Zigbee Channel	Threshold value 0..255	0
+ Room temperature controller	If Object value<Threshold value	Do not send telegram
+ Ventilation controller	If Object value=Threshold value	Do not send telegram
- Logic	If Object value!=Threshold value	Do not send telegram
	If Object value>Threshold value	Do not send telegram
	If Object value<=Threshold value	Do not send telegram
	If Object value>=Threshold value	Do not send telegram
Logic function setting		
<b>1st Logic</b>	Output send when	<input checked="" type="radio"/> Receiving a new telegram <input type="radio"/> Every change of output object
2nd Logic	Send delay time: Base	None
3rd Logic	Factor: 1..255	1
4th Logic		

Fig.5.6.3 “Threshold comparator” parameter window

### Parameter “Threshold value data type”

This parameter is for setting the threshold value data type. Options:

**4bit**

**1byte**

**2byte**

**4byte**

**Parameter “Threshold value 0..255”**

This parameter is for setting threshold value, the range depends on the data type. Options: **4bit 0..15/1byte 0..255/ 2byte 0..65535 /4byte 0..4294967295**

**Parameter “If Object value<Thresholdvalue”****Parameter “If Object value!=Thresholdvalue”****Parameter “If Object value<Thresholdvalue”****Parameter “If Object value<Thresholdvalue”****Parameter “If Object value<Thresholdvalue”**

This parameter is for setting the logic result value that should be sent when threshold value Less than, equal to, not equal to, greater than, less than or equal to the setting valve. Options:

**Do not send telegram**

**Send value “0”**

**Send value “1”**

Do not send telegram: not consider to select this option;

Send value “0”/“1”: when condition is satisfied, send telegram 0 or 1.

If there is a conflict between the setting options between parameters, the base on the value that should be sent when reach the final parameter condition. **For example: parameter “If Object value=Threshold value” is set to be “Send value “0””; parameter “If Object value<=Thresholdvalue” is set to be “Send value “1””; when object value is equal to the threshold value, then the logic result will send “1”.**

**Parameter “Output send when”**

This parameter is for setting the condition of sending logic result. Options:

**Receiving a new telegram**

**Every change of output object**

Receiving a new telegram: every time the object received a new input value will the logic result be sent to the bus;

Every change of output object: only when logic result has changed will it be sent to the bus.

**Tip: when in the first time to logic algorithm, the logic result will be sent even if it has no change.**

### Parameter “Send delay time”

**Base:**            **None**  
                       **0.1s**  
                       **1s**  
                       **...**  
                       **10s**  
                       **25s**

**Factor:**        **1..255**

This parameter is for setting the delay time for sending the logic algorithm result to the bus. Delay time = Base x Factor, if option “None” of Base is selected, then there is no delay.

#### 5.6.4. Parameter window “Format convert”

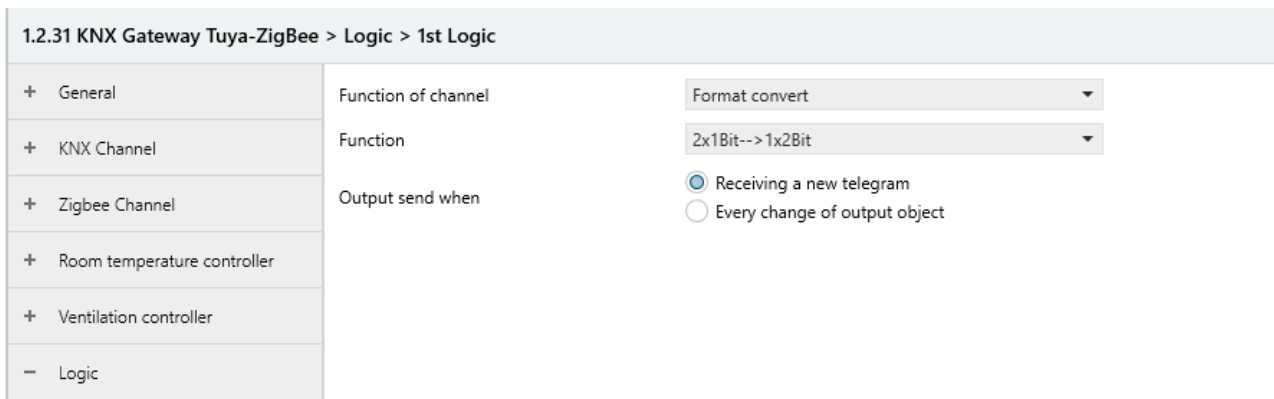

Fig.5.6.4 “Format convert” parameter window

### Parameter “Function”

This parameter is for setting the format convert type. Options:

- 2x1bit-->1x2bit**
- 8x1bit-->1x1byte**
- 1x1byte-->1x2byte**
- 2x1byte-->1x2byte**
- 2x2byte-->1x4byte**
- 1x1byte-->8x1bit**
- 1x2byte-->2x1byte**
- 1x4byte-->2x2byte**
- 1x3byte-->3x1byte**
- 3x1byte-->1x3byte**

## Parameter “Output send when”

This parameter is for setting the condition of sending logic result. Options:

**Receiving a new telegram**

**Every change of output object**

Receiving a new telegram: every time the object received a new input value will the logic result be sent to the bus;

Every change of output object: only when logic result has changed will it be sent to the bus.

**Tip: when in the first time to logic algorithm, the logic result will be sent even if it has no change.**

### 5.6.5. Parameter window “Gate function”

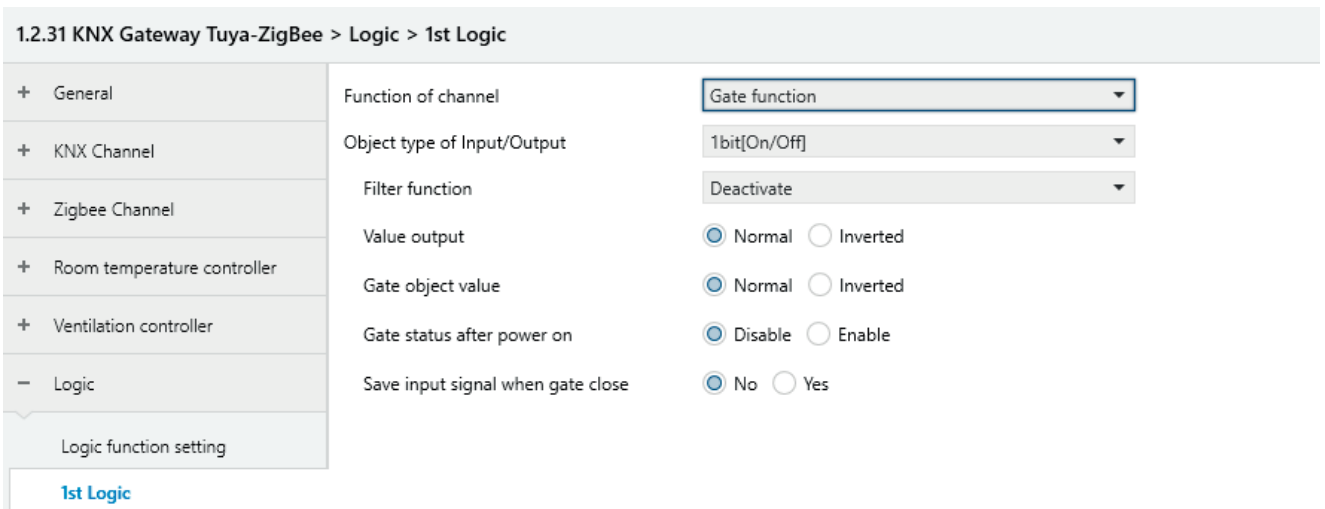

Fig.5.6.5 “Gate function” parameter window

## Parameter “Object type of Input/Output”

This parameter is for setting the object type of input/output. Options:

**1bit[On/Off]**

**1byte[0..100%]**

**1byte[0..255]**

**2byte[Float]**

**2byte[0..65535]**

### ——Parameter “Filterfunction”

This parameter is visible when “1bit[On/Off]” is selected. Set whether to filter On or Off telegram, only pass one of them or pass all. Options:

**Deactivate**

**On filter out**

**Off filter out**

Deactivate: Do not filter the On or Off telegrams;

On filter out: Off can pass, On cannot pass;

Off filter out: On can pass, Off cannot pass.

#### —Parameter “Value output”

This parameter is visible when “1bit[On/Off]” is selected. Set whether to invert the value then output it. Options:

**Normal**

**Inverted**

#### Parameter “Gate object value”

This parameter is for setting whether to invert the gate object value then output it. Options:

**Normal**

**Inverted**

#### Parameter “Gate status after power on”

This parameter is for setting the gate status after power on. Options:

**Disable**

**Enable**

#### Parameter “Save input signal when gate close”

This parameter is for setting whether to save input signal on gate close. Options:

**No**

**Yes**

No: disable to save the input, the input values received during the gate closing period are ignored;

Yes: enable to save the input, the input values received during the gate closing period are output when gate is open (whether the input value is changed or not).



### 5.6.6. Parameter window “Delay function”

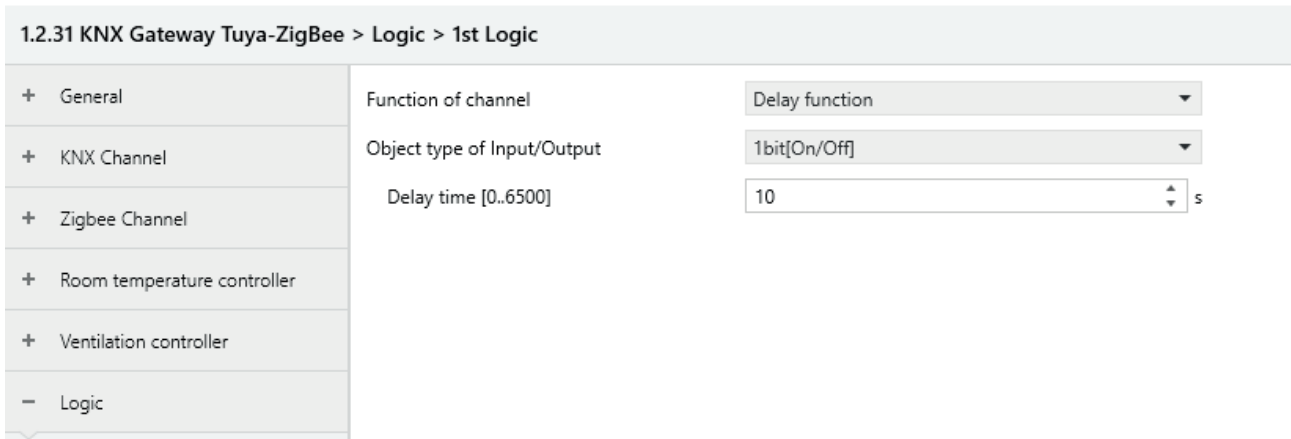

Fig.5.6.6 “Delay function” parameter window

### Parameter “Object type of Input/Output”

This parameter is for setting the object type of input/output. Options:

**1bit[On/Off]**

**1byte[0..100%]**

**1byte[0..255]**

**2byte[Float]**

**2byte[0..65535]**

### —Parameter “Delay time [0..6500]s”

This parameter is for setting the delay time that output object forwards the value when the input object receives the telegram. Options: **0..6500**

**Note: Receive telegram again in delay time, re-timing.**

### 5.6.7. Parameter window “Staircase lighting”

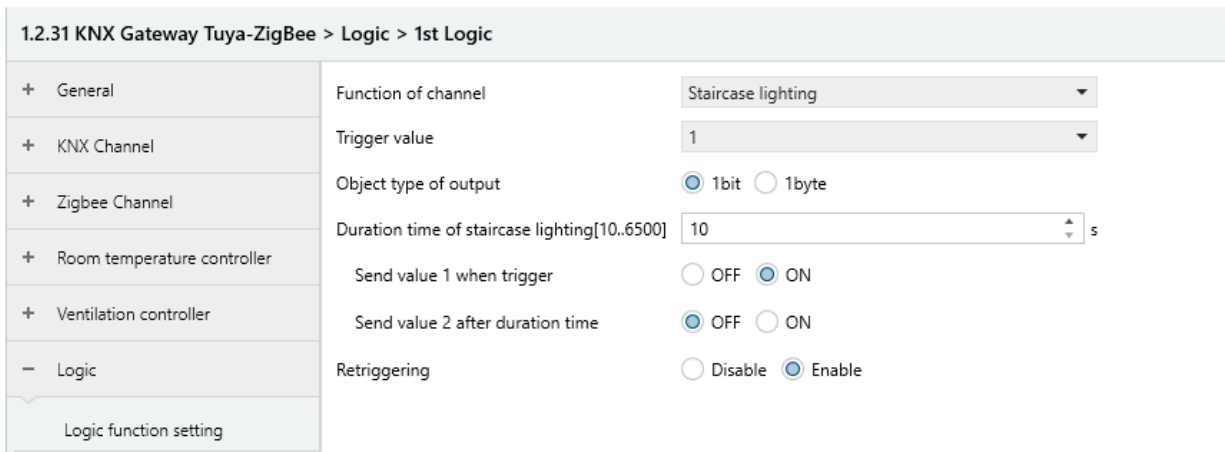

Fig.5.6.7 “Staircase lighting” parameter window

**Parameter “Trigger value”**

This parameter is for setting the telegram value of the object “Trigger value”. Options:

**0**

**1**

**0 or 1**

**Parameter “Object type of output”**

This parameter is for setting the object type of output. Options:

**1bit**

**1byte**

**Parameter “Durationtime of staircase lighting[10..6500]s”**

This parameter is for setting duration time of staircase lighting after the stair light power on.

Options: **10..6500**

—— Parameter “Send value 1 when trigger”

—— Parameter “Send value 2 after duration time”

These parameters are for setting the value to send. Send value 1 when trigger, and then send value 2 after duration time. Options display according to the output object datatype.

When 1 bit, options:

**OFF**

**ON**

When 1 byte, options: **0..255**

**Parameter “Retriggering”**

This parameter is for setting whether to trigger re-timing when received trigger value in delay time.

Options:

**Disable**

**Enable**

## Chapter 6 Description of Communication Object

The communication object is the medium to communicate other device on the bus, namely only the communication object can communicate with the bus.

**NOTE:** “C” in “Flag” column in the below table means enable the communication function of the object; “W” means value of object can be written from the bus; “R” means the value of the object can be read by the other devices; “T” means the object has the transmission function; “U” means the value of the object can be updated.

### 6.1. “General” Communication Object

Number	Name	Object Function	Description	Group Address	Length	C	R	W	T	U	Data Type	Priority
1	General	In operation			1 bit	C	R	-	T	-	switch	Low

Fig.6.1 “General” Communication Object

NO.	Object Function	Name	Data Type	Flag	DPT
1	In operation	General	1bit	C,R,T	1.001 switch

The communication object is used to periodically send a telegram “1” to the bus to indicate that the device is working properly.

Table 6.1 “General” communication object table

### 6.2. “KNX Channel” Communication Object

Numb	Name	Object Function	Description	Group Address	Length	C	R	W	T	U	Data Type	Priority
300	KNX General	Device online common 1, status			1 bit	C	-	W	T	U	switch	Low
301	KNX General	Device online common 2, status			1 bit	C	-	W	T	U	switch	Low
302	KNX General	Device online common 3, status			1 bit	C	-	W	T	U	switch	Low
303	KNX General	Device online common 4, status			1 bit	C	-	W	T	U	switch	Low
304	KNX General	Device online common 5, status			1 bit	C	-	W	T	U	switch	Low
305	KNX General	Device online common 6, status			1 bit	C	-	W	T	U	switch	Low
306	KNX General	Device online common 7, status			1 bit	C	-	W	T	U	switch	Low
307	KNX General	Device online common 8, status			1 bit	C	-	W	T	U	switch	Low
308	KNX General	Device online common 9, status			1 bit	C	-	W	T	U	switch	Low
309	KNX General	Device online common 10, status			1 bit	C	-	W	T	U	switch	Low
310	KNX: Channel 1	Device online, status			1 bit	C	-	W	T	U	switch	Low

Fig.6.2 KNX general communication Object

NO.	Object Function	Name	Data Type	Flag	DPT
300/.../309	Device online common x, status	KNX General	1bit	C,W,T,U	1.001 switch
<p>The communication object is used to send the request to the bus, for common device to query the KNX device online status, and also can receive the feedback. Telegrams:</p> <p>0—Offline 1—Online</p> <p>Suitable for devices with multiple circuits. For example, multiple channels of gateway may be multiple circuits that control the same KNX device, so each channel can share one request.</p>					
310	Device online, status	KNX: {{Channel1}}	1bit	C,W,T,U	1.001 switch
<p>The communication object is used to send the request to the bus, for independent device to query the KNX device online status, and also can receive the feedback. Telegrams:</p> <p>0—Offline 1—Online</p> <p>Suitable for a device that only controlled by the single channel of gateway.</p> <p>The name in parentheses changes with the parameter “Description (max 30 char.)”. If description is empty, display “...Channel x” by default. The same below.</p>					

Table 6.2 KNX general communication object table

### 6.2.1. Communication Object of basic function

Numb	Name	Object Function	Description	Group Address	Length	C	R	W	T	U	Data Type	Priority
311	KNX: Channel 1	Switch			1 bit	C	-	-	T	-	switch	Low
312	KNX: Channel 1	Switch, status			1 bit	C	-	W	T	U	switch	Low
Switch												
Numb	Name	Object Function	Description	Group Address	Length	C	R	W	T	U	Data Type	Priority
311	KNX: Channel 1	Switch			1 bit	C	-	-	T	-	switch	Low
312	KNX: Channel 1	Brightness dimming			1 byte	C	-	-	T	-	percentage (0..100%)	Low
313	KNX: Channel 1	Brightness, status			1 byte	C	-	W	T	U	percentage (0..100%)	Low
Switch/Dimming												
Numb	Name	Object Function	Description	Group Address	Length	C	R	W	T	U	Data Type	Priority
311	KNX: Channel 1	Switch			1 bit	C	-	-	T	-	switch	Low
312	KNX: Channel 1	Switch, status			1 bit	C	-	W	T	U	switch	Low
313	KNX: Channel 1	RGB dimming value			3 bytes	C	-	-	T	-	RGB value 3x(0..255)	Low
317	KNX: Channel 1	RGB brightness, status			3 bytes	C	-	W	T	U	RGB value 3x(0..255)	Low

313	KNX: Channel 1	Red dimming value	1 byte	C	-	-	T	-	percentage (0..100%)	Low
314	KNX: Channel 1	Green dimming value	1 byte	C	-	-	T	-	percentage (0..100%)	Low
315	KNX: Channel 1	Blue dimming value	1 byte	C	-	-	T	-	percentage (0..100%)	Low
317	KNX: Channel 1	Red brightness, status	1 byte	C	-	W	T	U	percentage (0..100%)	Low
318	KNX: Channel 1	Green brightness, status	1 byte	C	-	W	T	U	percentage (0..100%)	Low
319	KNX: Channel 1	Blue brightness, status	1 byte	C	-	W	T	U	percentage (0..100%)	Low

#### RGB dimming

Numb	Name	Object Function	Description	Group Address	Length	C	R	W	T	U	Data Type	Priority
311	KNX: Channel 1	Switch			1 bit	C	-	-	T	-	switch	Low
312	KNX: Channel 1	Switch, status			1 bit	C	-	W	T	U	switch	Low
313	KNX: Channel 1	RGBW dimming value			6 bytes	C	-	-	T	-	RGBW value 4x(0..100%)	Low
317	KNX: Channel 1	RGBW brightness, status			6 bytes	C	-	W	T	U	RGBW value 4x(0..100%)	Low

#### RGBW dimming(1)

313	KNX: Channel 1	Red dimming value	1 byte	C	-	-	T	-	percentage (0..100%)	Low
314	KNX: Channel 1	Green dimming value	1 byte	C	-	-	T	-	percentage (0..100%)	Low
315	KNX: Channel 1	Blue dimming value	1 byte	C	-	-	T	-	percentage (0..100%)	Low
316	KNX: Channel 1	White dimming value	1 byte	C	-	-	T	-	percentage (0..100%)	Low
317	KNX: Channel 1	Red brightness, status	1 byte	C	-	W	T	U	percentage (0..100%)	Low
318	KNX: Channel 1	Green brightness, status	1 byte	C	-	W	T	U	percentage (0..100%)	Low
319	KNX: Channel 1	Blue brightness, status	1 byte	C	-	W	T	U	percentage (0..100%)	Low
320	KNX: Channel 1	White brightness, status	1 byte	C	-	W	T	U	percentage (0..100%)	Low

#### RGBW dimming(2)

Numb	Name	Object Function	Description	Group Address	Length	C	R	W	T	U	Data Type	Priority
311	KNX: Channel 1	Switch			1 bit	C	-	-	T	-	switch	Low
312	KNX: Channel 1	Switch, status			1 bit	C	-	W	T	U	switch	Low
313	KNX: Channel 1	Color temperature value			2 bytes	C	-	-	T	-	absolute colour temperature (K)	Low
314	KNX: Channel 1	Brightness value			1 byte	C	-	-	T	-	percentage (0..100%)	Low
317	KNX: Channel 1	Color temperature, status			2 bytes	C	-	W	T	U	absolute colour temperature (K)	Low
318	KNX: Channel 1	Brightness, status			1 byte	C	-	W	T	U	percentage (0..100%)	Low

#### Color temperature

Numb	Name	Object Function	Description	Group Address	Length	C	R	W	T	U	Data Type	Priority
311	KNX: Channel 1	Open/Close			1 bit	C	-	-	T	-	open/close	Low
312	KNX: Channel 1	Stop			1 bit	C	-	-	T	-	step	Low

#### Curtain step/move

Numb	Name	Object Function	Description	Group Address	Length	C	R	W	T	U	Data Type	Priority
311	KNX: Channel 1	Up/Down			1 bit	C	-	-	T	-	up/down	Low
312	KNX: Channel 1	Stop			1 bit	C	-	-	T	-	step	Low

#### Rollerblind step/move

Numb	Name	Object Function	Description	Group Address	Length	C	R	W	T	U	Data Type	Priority
311	KNX: Channel 1	Open/Close			1 bit	C	-	-	T	-	open/close	Low
312	KNX: Channel 1	Stop			1 bit	C	-	-	T	-	step	Low
313	KNX: Channel 1	Blind position			1 byte	C	-	-	T	-	percentage (0..100%)	Low
315	KNX: Channel 1	Blind position, status			1 byte	C	-	W	T	U	percentage (0..100%)	Low

#### Curtain position

Numb	Name	Object Function	Description	Group Address	Length	C	R	W	T	U	Data Type	Priority
311	KNX: Channel 1	Up/Down			1 bit	C	-	-	T	-	up/down	Low
312	KNX: Channel 1	Stop			1 bit	C	-	-	T	-	step	Low
313	KNX: Channel 1	Blind position			1 byte	C	-	-	T	-	percentage (0..100%)	Low
315	KNX: Channel 1	Blind position, status			1 byte	C	-	W	T	U	percentage (0..100%)	Low

#### Rollerblind position

Numb	Name	Object Function	Description	Group Address	Length	C	R	W	T	U	Data Type	Priority
311	KNX: Channel 1	Up/Down			1 bit	C	-	-	T	-	open/close	Low
312	KNX: Channel 1	Stop/Slat adj.			1 bit	C	-	-	T	-	step	Low
313	KNX: Channel 1	Blind position			1 byte	C	-	-	T	-	percentage (0..100%)	Low
314	KNX: Channel 1	Slat position			1 byte	C	-	-	T	-	percentage (0..100%)	Low
315	KNX: Channel 1	Blind position, status			1 byte	C	-	W	T	U	percentage (0..100%)	Low
316	KNX: Channel 1	Slat position, status			1 byte	C	-	W	T	U	percentage (0..100%)	Low

#### Venetian blind position and slat

Numb	Name	Object Function	Description	Group Address	Length	C	R	W	T	U	Data Type	Priority
311	KNX: Channel 1	Send 1bit value			1 bit	C	-	-	T	-	switch	Low
311	KNX: Channel 1	Send 2bit value			2 bit	C	-	-	T	-	switch control	Low
311	KNX: Channel 1	Send 1byte percent value			1 byte	C	-	-	T	-	percentage (0..100%)	Low
311	KNX: Channel 1	Send 1byte unsigned value			1 byte	C	-	-	T	-	counter pulses (0..255)	Low
311	KNX: Channel 1	Recall scene No.			1 byte	C	-	-	T	-	scene number	Low
311	KNX: Channel 1	Send 2byte float value			2 bytes	C	-	-	T	-	2-byte float value	Low
311	KNX: Channel 1	Send 2byte unsigned value			2 bytes	C	-	-	T	-	pulses	Low

Value sender

Numb	Name	Object Function	Description	Group Address	Length	C	R	W	T	U	Data Type	Priority
311	KNX: Channel 1	Trigger scene No.			1 byte	C	-	W	-	-	scene number	Low

Scene switch

Fig.6.2.1 Basic function communication object

NO.	Object Function	Name	Data Type	Flag	DPT
311	Switch	KNX: {{Channel1}}	1bit	C,T	1.001 switch
312	Switch, status	KNX: {{Channel1}}	1bit	C,W,T,U	1.001 switch
<p>These two communication objects apply to switch, dimming, color and color temperature control. Telegrams:</p> <p>0—Turn off the light</p> <p>1—Turn on the light</p> <p>Obj.311: Used for sending On/Off telegrams to the bus, to control the light on/off.</p> <p>Obj.312: Used for receiving On/Off status responded from other bus devices, such as dimming actuator, switch actuator.</p>					
312	Brightness dimming	KNX: {{Channel1}}	1byte	C,T	5.001 percentage(0..100%)
313	Brightness, status	KNX: {{Channel1}}	1byte	C,W,T,U	5.001 percentage(0..100%)
<p>These two communication objects apply to brightness dimming. Telegrams: 0~100%</p> <p>Obj.312: Used for sending dimming telegrams to the bus, that is, sending the brightness value.</p> <p>Obj.313: Used for receiving brightness status responded from dimming actuator.</p>					
313	Red dimming value	KNX: {{Channel1}}	1byte	C,T	5.001 percentage(0..100%)
317	Red brightness, status	KNX: {{Channel1}}	1byte	C,W,T,U	5.001 percentage(0..100%)
<p>These two communication objects are visible when 3x1byte for the RGB object type or 4x1byte for the RGBW object type is selected. Apply to control brightness of multi-color lamp, and also support color temperature adjustment. Telegrams: 0...100%</p> <p>Obj.313 Used for sending brightness value of the control R (red) channel to the bus.</p> <p>Obj.317: Used for receiving brightness value of the control R (red) channel from bus.</p>					
314	Green dimming value	KNX: {{Channel1}}	1byte	C,T	5.001 percentage(0..100%)

<b>318</b>	<b>Green brightness, status</b>	<b>KNX: {{Channel1}}</b>	<b>1byte</b>	<b>C,W,T,U</b>	<b>5.001 percentage(0..100%)</b>									
<p>These two communication objects are visible when 3x1byte for the RGB object type or 4x1byte for the RGBW object type is selected. Apply to control brightness of multi-color lamp, and also support color temperature adjustment. Telegrams: 0...100%</p> <p>Obj.314: Used for sending brightness value of the control G (green) channel to the bus.</p> <p>Obj.318: Used for receiving brightness value of the control G (green) channel from bus.</p>														
<b>315</b>	<b>Blue dimming value</b>	<b>KNX: {{Channel1}}</b>	<b>1byte</b>	<b>C,T</b>	<b>5.001 percentage(0..100%)</b>									
<b>319</b>	<b>Blue brightness, status</b>	<b>KNX: {{Channel1}}</b>	<b>1byte</b>	<b>C,W,T,U</b>	<b>5.001 percentage(0..100%)</b>									
<p>These two communication objects are visible when 3x1byte for the RGB object type or 4x1byte for the RGBW object type is selected. Apply to control brightness of multi-color lamp, and also support color temperature adjustment. Telegrams: 0...100%</p> <p>Obj.315: Used for sending brightness value of the control B (blue) channel to the bus.</p> <p>Obj.319: Used for receiving brightness value of the control B (blue) channel from bus.</p>														
<b>316</b>	<b>White dimming value</b>	<b>KNX: {{Channel1}}</b>	<b>1byte</b>	<b>C,T</b>	<b>5.001 percentage(0..100%)</b>									
<b>320</b>	<b>White brightness, status</b>	<b>KNX: {{Channel1}}</b>	<b>1byte</b>	<b>C,W,T,U</b>	<b>5.001 percentage(0..100%)</b>									
<p>These two communication objects are visible when 4x1byte for the RGBW object type is selected. Apply to control brightness of multi-color lamp, and also support color temperature adjustment. Telegrams: 0...100%</p> <p>Obj.316: Used for sending brightness value of the control W (white) channel to the bus.</p> <p>Obj.320: Used for receiving brightness value of the control W (white) channel from bus.</p>														
<b>313</b>	<b>RGB dimming value</b>	<b>KNX: {{Channel1}}</b>	<b>3byte</b>	<b>C,T</b>	<b>232.600 RGB value 3x(0..255)</b>									
<b>317</b>	<b>RGB brightness, status</b>	<b>KNX: {{Channel1}}</b>	<b>3byte</b>	<b>C,W,T,U</b>	<b>232.600 RGB value 3x(0..255)</b>									
<p>These two communication objects are visible when 1x3byte for the RGB object type is selected. Apply to control brightness of multi-color lamp, and also support color temperature adjustment.</p> <p>Obj.313: Used for sending brightness value of RGB three-color lamp to the bus.</p> <p>Obj.317: Used for receiving brightness value of RGB three-color lamp from bus.</p> <p>3-Byte Code for RGB Dimming Object Data Type: U8 U8 U8, as follows:</p> <table border="1" data-bbox="290 1823 1094 1975"> <tr> <td>3<sub>MSB</sub></td> <td>2</td> <td>1<sub>LSB</sub></td> </tr> <tr> <td>R</td> <td>G</td> <td>B</td> </tr> <tr> <td>UUUUUUUU</td> <td>UUUUUUUU</td> <td>UUUUUUUU</td> </tr> </table> <p>R: red dimming value; G: green dimming value; B: blue dimming value.</p>						3 <sub>MSB</sub>	2	1 <sub>LSB</sub>	R	G	B	UUUUUUUU	UUUUUUUU	UUUUUUUU
3 <sub>MSB</sub>	2	1 <sub>LSB</sub>												
R	G	B												
UUUUUUUU	UUUUUUUU	UUUUUUUU												

313	RGBW dimming value	KNX: {{Channel1}}	6byte	C,T	251.600 DPT_Colour_RGBW
317	RGBW brightness, status	KNX: {{Channel1}}	6byte	C,W,T,U	251.600 DPT_Colour_RGBW

These two communication objects are visible when 1x6byte for the RGBW object type is selected.  
Apply to control brightness of multi-colorlamp, and also support color temperature adjustment.

6 <sub>MSB</sub>	5	4	3	2	1 <sub>LSB</sub>
R	G	B	W	Reserve	r r r r mR mG mB mW
UUUUUUUU	UUUUUUUU	UUUUUUUU	UUUUUUUU	0000000 0	0000BBBB

R: red dimming value; G: green dimming value; B: blue dimming value; W: white dimming value;  
mR: determines whether the red dimming value is valid, 0 = invalid, 1 = valid;  
mG: determines whether the green dimming value is valid, 0 = invalid, 1 = valid;  
mB: determines whether the blue dimming value is valid, 0 = invalid, 1 = valid;  
mW: Determines whether the white dimming value is valid, 0 = invalid, 1 = valid.

313	Color temperature value	KNX: {{Channel1}}	2byte	C,T	7.600 absolute color temperature
317	Color temperature, status	KNX: {{Channel1}}	2byte	C,W,T,U	7.600 absolute color temperature

These two communication objects apply to color temperature adjustment of monochrome lamp.  
Telegrams: 2000..7000 K  
Obj.313: Used for sending the control telegram of the color temperature to the bus.  
Obj.317: Used for receiving the control telegram of the color temperature from bus.

314	Brightness value	KNX: {{Channel1}}	1byte	C,T	5.001 percentage(0..100%)
318	Brightness, status	KNX: {{Channel1}}	1byte	C,W,T,U	5.001 percentage(0..100%)

These two communication objects apply to color temperature adjustment of monochrome lamp.  
Telegrams: 0...100%  
Obj.314: Used for sending the dimming telegram of the color temperature to the bus, that is, sending the brightness value.  
Obj.318: Used for receiving the brightness status responded from the dimming actuator.



311	Open/Close	KNX: {{Channel1}}	1bit	C,T	1.009 open/close
312	Stop	KNX: {{Channel1}}	1bit	C,T	1.007 step
<p>Curtain step/move: these two communication objects apply to open and close curtain. Support to open, close, stop.</p> <p>Obj.311: Used for sending the telegram to the bus, to control curtain open/close. Telegrams:</p> <p style="padding-left: 40px;">1—Close the curtain</p> <p style="padding-left: 40px;">0—Open the curtain</p> <p>Obj.312: Used for sending the telegram to the bus, to stop curtain movement. Telegrams:</p> <p style="padding-left: 40px;">1—Stop</p>					
311	Up/Down	KNX: {{Channel1}}	1bit	C,T	1.008 up/down
312	Stop	KNX: {{Channel1}}	1bit	C,T	1.007 step
<p>Roller blind step/move: these two communication objects apply to roller blind. Support to up, down, stop.</p> <p>Obj.311: Used for sending the telegram to the bus, to control blind up/down. Telegrams:</p> <p style="padding-left: 40px;">1—Move down</p> <p style="padding-left: 40px;">0—Move up</p> <p>Obj.312 is the same as above.</p>					
311	Open/Close	KNX: {{Channel1}}	1bit	C,T	1.009 open/close
312	Stop	KNX: {{Channel1}}	1bit	C,T	1.007 step
313	Blind position	KNX: {{Channel1}}	1byte	C,T	5.001 percentage(0..100%)
315	Blind position, status	KNX: {{Channel1}}	1byte	C,W,T,U	5.001 percentage(0..100%)
<p>Curtain position: apply to open and close curtain. Support to open, close, stop, position adjustment and position status feedback.</p> <p>Obj.311: Used for sending the telegram to the bus, to control curtain open/close. Telegrams:</p> <p style="padding-left: 40px;">1—Close the curtain</p> <p style="padding-left: 40px;">0—Open the curtain</p> <p>Obj.312: Used for sending the telegram to the bus, to stop curtain movement. Telegrams:</p> <p style="padding-left: 40px;">1—Stop</p> <p>Obj.313: Used for sending a telegram to control the position of the curtain to the bus. Telegrams: 0...100%</p> <p>Obj.315: Used for receiving a curtain position status in response to the window curtain actuator on the bus. Telegrams: 0...100%</p>					

311	Up/Down	KNX: {{Channel1}}	1bit	C,T	1.008 up/down
312	Stop	KNX: {{Channel1}}	1bit	C,T	1.007 step
313	Blind position	KNX: {{Channel1}}	1byte	C,T	5.001 percentage(0..100%)
315	Blind position, status	KNX: {{Channel1}}	1byte	C,W,T,U	5.001 percentage(0..100%)
<p>Roller blind position: apply to a roller blind without slat. Support to up, down, stop, position adjustment and position status feedback.</p> <p>Obj.311: Used for sending the telegram to the bus, to control blind up/down. Telegrams:</p> <p style="padding-left: 40px;">1— Move down</p> <p style="padding-left: 40px;">0— Move up</p> <p>Obj.312, Obj.313, Obj.315 are the same as above.</p>					
311	Up/Down	KNX: {{Channel1}}	1bit	C,T	1.008 up/down
312	Stop/Slat adj.	KNX: {{Channel1}}	1bit	C,T	1.007 step
313	Blind position	KNX: {{Channel1}}	1byte	C,T	5.001 percentage(0..100%)
314	Slat position	KNX: {{Channel1}}	1byte	C,T	5.001 percentage(0..100%)
315	Blind position, status	KNX: {{Channel1}}	1byte	C,W,T,U	5.001 percentage(0..100%)
316	Slat position, status	KNX: {{Channel1}}	1byte	C,W,T,U	5.001 percentage(0..100%)
<p>Venetian blind position and slat: apply to a blind with slat. Support to up, down, stop, position and slat adjustment, position and slat status feedback.</p> <p>Obj.311: Obj.313 and Obj.315 are same as above.</p> <p>Obj.312: Used for sending a telegram to the bus to stop the curtain movement or adjust the slat angle. Telegrams:</p> <p style="padding-left: 40px;">1— Stop/Slat adj. Down</p> <p style="padding-left: 40px;">0— Stop/Slat adj. Up</p> <p>Obj.314: Used for sending a telegram to control the position of the blind to the bus. Telegrams: 0...100%</p> <p>Obj.316: Used for receiving a blind position status in response to the blind actuator on the bus. Telegrams: 0...100%</p>					

311	Send 1bit value	KNX: {{Channel 1}}	1bit on/off	C,T	1.001 switch
	Send 2bit value		2bit 0..3		2.001 switch control
	Send 1byte percent value		1byte 0..100%		5.001
	Send 1byte unsigned value		1byte 0..255		percentage(0..100%)
	Recall scene No.		1byte 1..64		5.010 counter pulses
	Send 2byte float value		2byte		17.001 scene number
	Send 2byte unsigned value		-671088.64..670760.96		9.x float value
7.001 pulses					
<p>The communication object is used for sending a preset telegram to the bus when trigger the calling command on the APP. Object type and value range are determined by the parameter setting datatype.</p>					
311	Trigger scene No.	KNX: {{Channel 1}}	2byte	C,W	17.001 scene number
<p>The communication object is used for receiving the scene triggered telegram from KNX system. Telegram: 1..64</p>					

Table 6.2.1 Basic function communication object table

## 6.2.2. Communication Object of Air condition

Numb	Name	Object Function	Description	Group Address	Length	C	R	W	T	U	Data Type	Priority
311	KNX: Channel 1	Power on/off			1 bit	C	-	-	T	-	switch	Low
312	KNX: Channel 1	Current setpoint adjustment			2 bytes	C	-	-	T	-	temperature (°C)	Low
313	KNX: Channel 1	Control mode			1 byte	C	-	-	T	-	HVAC control mode	Low
314	KNX: Channel 1	Fan speed			1 byte	C	-	-	T	-	percentage (0..100%)	Low
317	KNX: Channel 1	Power on/off, status			1 bit	C	-	W	-	-	switch	Low
318	KNX: Channel 1	Room temperature sensor			2 bytes	C	-	W	T	U	temperature (°C)	Low
319	KNX: Channel 1	Current temperature setpoint, status			2 bytes	C	-	W	-	U	temperature (°C)	Low
320	KNX: Channel 1	Control mode, status			1 byte	C	-	W	-	-	HVAC control mode	Low
321	KNX: Channel 1	Fan speed, status			1 byte	C	-	W	-	-	percentage (0..100%)	Low

Air conditioner

Numb	Name	Object Function	Description	Group Address	Length	C	R	W	T	U	Data Type	Priority
311	KNX: Channel 1	Power on/off			1 bit	C	-	-	T	-	switch	Low
312	KNX: Channel 1	Current setpoint adjustment			2 bytes	C	-	-	T	-	temperature (°C)	Low
313	KNX: Channel 1	Control mode			1 byte	C	-	-	T	-	HVAC control mode	Low
314	KNX: Channel 1	Fan speed			1 byte	C	-	-	T	-	percentage (0..100%)	Low
315	KNX: Channel 1	Vanes swing (1-swing,0-stop)			1 bit	C	-	-	T	-	start/stop	Low
317	KNX: Channel 1	Power on/off, status			1 bit	C	-	W	-	-	switch	Low
318	KNX: Channel 1	Room temperature sensor			2 bytes	C	-	W	T	U	temperature (°C)	Low
319	KNX: Channel 1	Current temperature setpoint, status			2 bytes	C	-	W	-	U	temperature (°C)	Low
320	KNX: Channel 1	Control mode, status			1 byte	C	-	W	-	-	HVAC control mode	Low
321	KNX: Channel 1	Fan speed, status			1 byte	C	-	W	-	-	percentage (0..100%)	Low
322	KNX: Channel 1	Vanes swing (1-swing,0-stop), status			1 bit	C	-	W	-	-	start/stop	Low

Air conditioner(with swing)

Fig.6.2.2 Air condition function communication object

NO.	Object Function	Name	Data Type	Flag	DPT
311	<b>Power on/off</b>	<b>KNX: {{Channel1}}</b>	<b>1bit</b>	<b>C,T</b>	<b>1.001 switch</b>
<p>The communication object is used to control air condition power on/off via the APP, and send the telegram value to the bus. Telegrams:</p> <p style="padding-left: 40px;">1—On</p> <p style="padding-left: 40px;">0—Off</p>					
312	<b>Currentsetpoint adjustment</b>	<b>KNX: {{Channel1}}</b>	<b>2byte</b>	<b>C,T</b>	<b>9.001 temperature</b>
<p>The communication object is used to adjust setpoint temperature via the APP, and send telegram value to the bus.</p>					
313	<b>Control mode</b>	<b>KNX: {{Channel1}}</b>	<b>1byte</b>	<b>C,T</b>	<b>20.105 HVAC control mode</b>
<p>The communication object is used to send control telegram of each air condition mode to the bus.</p> <p>Different telegram means different control mode:</p> <p>0-Auto, 1- Heating, 3-Cooling, 9-Fan, 14-Dehumidity, other reserved.</p>					
314	<b>Fan speed</b>	<b>KNX: {{Channel1}}</b>	<b>1byte</b>	<b>C,T</b>	<b>5.001 percentage</b> <b>5.100 fan stage</b>
<p>The communication object is used to send control telegram of each fan speed to the bus. Telegram value is determined by parameter setting datatype.</p>					
315	<b>Vanes swing (1-swing,0-stop)</b>	<b>KNX: {{Channel1}}</b>	<b>1bit</b>	<b>C,T</b>	<b>1.010 start/stop</b>
<p>The communication object is visible only when “Air conditioner(with swing)” is selected. Used to send telegram controlling vanes swing to the bus. Telegrams:</p> <p style="padding-left: 40px;">1—Swing</p> <p style="padding-left: 40px;">0—Stop</p>					
317	<b>Power on/off, status</b>	<b>KNX: {{Channel1}}</b>	<b>1bit</b>	<b>C,W</b>	<b>1.001 switch</b>
<p>The communication object is used to receive the power on/off telegram of air condition from the bus, and feedback to the APP display. Telegrams:</p> <p style="padding-left: 40px;">1—On</p> <p style="padding-left: 40px;">0—Off</p>					
318	<b>Room temperaturesensor</b>	<b>KNX: {{Channel1}}</b>	<b>2byte</b>	<b>C,W,T,U</b>	<b>9.001 temperature</b>
<p>The communication object is used to receive the room temperature from the bus, and send read request cyclically, and feedback to the APP display.</p>					

<b>319</b>	<b>Current temperaturesetpoint, status</b>	<b>KNX: {{Channel1}}</b>	<b>2byte</b>	<b>C,W,U</b>	<b>9.001 temperature</b>
The communication object is used to receive the current setpoint temperature from the bus, and feedback to the APP display.					
<b>320</b>	<b>Control mode, status</b>	<b>KNX: {{Channel1}}</b>	<b>1byte</b>	<b>C,W</b>	<b>20.105 HVAC control mode</b>
The communication object is used to receive the current control mode from the bus, and feedback to the APP display. Different telegram means different control mode: 0-Auto, 1- Heating, 3-Cooling, 9-Fan, 14-Dehumidity, other reserved.					
<b>321</b>	<b>Fan speed, status</b>	<b>KNX: {{Channel1}}</b>	<b>1byte</b>	<b>C,W</b>	<b>5.001 percentage</b> <b>5.100 fan stage</b>
The communication object is used to receive the current fan speed from the bus, and feedback to the APP display. Telegram value is determined by parameter setting datatype.					
<b>322</b>	<b>Vanes swing (1-swing,0-stop), status</b>	<b>KNX: {{Channel1}}</b>	<b>1bit</b>	<b>C,W</b>	<b>1.010 start/stop</b>
The communication object is visible only when “Air conditioner(with swing)” is selected. Used to receive vanes swing status from the bus. Telegrams:  1—Swing 0—Stop					

Table 6.2.2 Air condition function communication object table

### 6.2.3. Communication Object of Room temperatureunit

Numb	Name	Object Function	Description	Group Address	Length	C	R	W	T	U	Data Type	Priority
311	KNX: Channel 1	Power on/off			1 bit	C	-	-	T	-	switch	Low
312	KNX: Channel 1	Current setpoint adjustment			2 bytes	C	-	-	T	-	temperature (°C)	Low
313	KNX: Channel 1	Heating/Cooling mode			1 bit	C	-	-	T	-	cooling/heating	Low
325	KNX: Channel 1	Power on/off, status			1 bit	C	-	W	-	-	switch	Low
326	KNX: Channel 1	Room temperature sensor			2 bytes	C	-	W	T	U	temperature (°C)	Low
327	KNX: Channel 1	Current temperature setpoint, status			2 bytes	C	-	W	-	U	temperature (°C)	Low
328	KNX: Channel 1	Heating/Cooling mode, status			1 bit	C	-	W	-	-	cooling/heating	Low

Room temperature unit

Numb	Name	Object Function	Description	Group Address	Length	C	R	W	T	U	Data Type	Priority
311	KNX: Channel 1	Power on/off			1 bit	C	-	-	T	-	switch	Low
312	KNX: Channel 1	Current setpoint adjustment			2 bytes	C	-	-	T	-	temperature (°C)	Low
313	KNX: Channel 1	Heating/Cooling mode			1 bit	C	-	-	T	-	cooling/heating	Low
314	KNX: Channel 1	Operation mode			1 byte	C	-	-	T	-	HVAC mode	Low
325	KNX: Channel 1	Power on/off, status			1 bit	C	-	W	-	-	switch	Low
326	KNX: Channel 1	Room temperature sensor			2 bytes	C	-	W	T	U	temperature (°C)	Low
327	KNX: Channel 1	Current temperature setpoint, status			2 bytes	C	-	W	-	U	temperature (°C)	Low
328	KNX: Channel 1	Heating/Cooling mode, status			1 bit	C	-	W	-	-	cooling/heating	Low
329	KNX: Channel 1	Operation mode, status			1 byte	C	-	W	-	-	HVAC mode	Low

Room temperatureunit(with operation mode)

Numb	Name	Object Function	Description	Group Address	Length	C	R	W	T	U	Data Type	Priority
311	KNX: Channel 1	Power on/off			1 bit	C	-	-	T	-	switch	Low
312	KNX: Channel 1	Current setpoint adjustment			2 bytes	C	-	-	T	-	temperature (°C)	Low
313	KNX: Channel 1	Heating/Cooling mode			1 bit	C	-	-	T	-	cooling/heating	Low
314	KNX: Channel 1	Operation mode			1 byte	C	-	-	T	-	HVAC mode	Low
319	KNX: Channel 1	Fan speed			1 byte	C	-	-	T	-	percentage (0..100%)	Low
320	KNX: Channel 1	Fan speed low			1 bit	C	-	-	T	-	switch	Low
321	KNX: Channel 1	Fan speed medium			1 bit	C	-	-	T	-	switch	Low
322	KNX: Channel 1	Fan speed high			1 bit	C	-	-	T	-	switch	Low
324	KNX: Channel 1	Fan automatic operation			1 bit	C	-	-	T	-	enable	Low
325	KNX: Channel 1	Power on/off, status			1 bit	C	-	W	-	-	switch	Low
326	KNX: Channel 1	Room temperature sensor			2 bytes	C	-	W	T	U	temperature (°C)	Low
327	KNX: Channel 1	Current temperature setpoint, status			2 bytes	C	-	W	-	U	temperature (°C)	Low
328	KNX: Channel 1	Heating/Cooling mode, status			1 bit	C	-	W	-	-	cooling/heating	Low
329	KNX: Channel 1	Operation mode, status			1 byte	C	-	W	-	-	HVAC mode	Low
334	KNX: Channel 1	Fan speed, status			1 byte	C	-	W	-	-	percentage (0..100%)	Low
335	KNX: Channel 1	Fan speed low, status			1 bit	C	-	W	-	-	switch	Low
336	KNX: Channel 1	Fan speed medium, status			1 bit	C	-	W	-	-	switch	Low
337	KNX: Channel 1	Fan speed high, status			1 bit	C	-	W	-	-	switch	Low
339	KNX: Channel 1	Fan automatic operation, status			1 bit	C	-	W	-	-	enable	Low

Room temperature unit (with operation mode & fan speed)

Fig.6.2.3 Room temperature unit function communication Object

NO.	Object Function	Name	Data Type	Flag	DPT
311	Power on/off	KNX: {{Channel1}}	1bit	C,T	1.001 switch
<p>The communication object is used to control RTC power on/off via the APP, and send the telegram value to the bus. Telegrams:</p> <p style="text-align: center;">1—On</p> <p style="text-align: center;">0—Off</p>					
312	Current setpoint adjustment	KNX: {{Channel1}}	2byte	C,T	9.001 temperature
<p>The communication object is used to adjust setpoint temperature via the APP, and send telegram value to the bus.</p>					
313	Heating/Cooling mode	KNX: {{Channel1}}	1bit	C,T	1.100 cooling/heating
<p>The communication object is used to send telegram for switching cooling and heating functions to the bus. Telegrams:</p> <p style="text-align: center;">1—Heating</p> <p style="text-align: center;">0—Cooling</p>					
314	Operation mode	KNX: {{Channel1}}	1byte	C,T	20.102 HVAC mode
<p>The communication object is used to send the telegram of the room operation mode to the bus. Different telegram means different control mode:</p> <p style="text-align: center;">1-Comfort, 2-Standby, 3-Economy, 4-Protection, other reserved.</p>					
319	Fan speed	KNX: {{Channel1}}	1byte	C,T	5.001 percentage 5.100 fan stage
320	Fan speed low	KNX: {{Channel1}}	1bit	C,T	1.001 switch

321	Fan speed medium	KNX: {{Channel1}}	1bit	C,T	1.001 switch
322	Fan speed high	KNX: {{Channel1}}	1bit	C,T	1.001 switch
323	Fan speed off	KNX: {{Channel1}}	1bit	C,T	1.001 switch
<p>These communication objects are used to control fan speed via the APP, and send telegrams to the bus.</p> <p>1bit object is visible according to the parameter setting :</p> <p>Object 320 — Low fan speed</p> <p>Object 321 — Medium fan speed</p> <p>Object 322 — High fan speed</p> <p>Object 323 — Fan speed off</p> <p>Only the corresponding object sends telegram “1” when switch to a certain fan speed. When 1bit-off object is not enable, all objects send telegrams “0” when switch to fan speed off (The situation apply to connect with fan actuator of GVS);</p> <p>When 1bit-off object is enable, only 1bit-off object send telegram “1” (The situation apply to connect with fan actuator of other manufacturers).</p> <p>1byte: the corresponding telegram value of each fan speed is defined by the parameter. Activate the corresponding fan speed on the APP, and object 319 sends the corresponding telegram value of the fan speed to the bus.</p>					
324	Fan automatic operation	KNX: {{Channel1}}	1bit	C,T	1.003 enable
<p>The communication object is used to send the telegram of fan automatic control to the bus. Telegrams:</p> <p>1 — Auto</p> <p>0 — Exit auto</p>					
325	Power on/off, status	KNX: {{Channel1}}	1bit	C,W	1.001 switch
<p>The communication object is used to receive the power on/off telegram of RTC from the bus, and feedback to the APP display. Telegrams:</p> <p>1 — On</p> <p>0 — Off</p>					
326	Room temperature sensor	KNX: {{Channel1}}	2byte	C,W,T,U	9.001 temperature
<p>The communication object is used to receive the room temperature from the bus, and send read request cyclically, and feedback to the APP display.</p>					

327	<b>Current temperature setpoint, status</b>	<b>KNX: {{Channel1}}</b>	<b>2byte</b>	<b>C,W,U</b>	<b>9.001 temperature</b>
<p>The communication object is used to receive the current setpoint temperature from the bus, and feedback to the APP display.</p>					
328	<b>Heating/Cooling mode, status</b>	<b>KNX: {{Channel1}}</b>	<b>1bit</b>	<b>C,W</b>	<b>1.100 cooling/heating</b>
<p>The communication object is used for receiving the status of heating and cooling from the bus, and feedback to the APP display. Telegrams:</p> <p style="padding-left: 40px;">1 —Heating</p> <p style="padding-left: 40px;">0 —Cooling</p>					
329	<b>Operation mode, status</b>	<b>KNX: {{Channel1}}</b>	<b>1byte</b>	<b>C,W</b>	<b>20.102 HVAC mode</b>
<p>The communication object is used for receiving the telegram of RTC operation mode from the bus.</p> <p>Different telegram means different control mode:</p> <p>1-Comfort, 2-Standby, 3-Economy, 4-Protection, other reserved.</p>					
334	<b>Fan speed, status</b>	<b>KNX: {{Channel1}}</b>	<b>1byte</b>	<b>C,W</b>	<b>5.001 percentage</b> <b>5.100 fan stage</b>
335	<b>Fan speed low, status</b>	<b>KNX: {{Channel1}}</b>	<b>1bit</b>	<b>C,W</b>	<b>1.001 switch</b>
336	<b>Fan speed medium, status</b>	<b>KNX: {{Channel1}}</b>	<b>1bit</b>	<b>C,W</b>	<b>1.001 switch</b>
337	<b>Fan speed high, status</b>	<b>KNX: {{Channel1}}</b>	<b>1bit</b>	<b>C,W</b>	<b>1.001 switch</b>
338	<b>Fan speed off, status</b>	<b>KNX: {{Channel1}}</b>	<b>1bit</b>	<b>C,W</b>	<b>1.001 switch</b>
<p>These communication objects are used to receive status feedback to control fan speed via four 1bit objects or a 1byte object.</p> <p>1bit :</p> <p style="padding-left: 40px;">Object 335 —Low fan speed</p> <p style="padding-left: 40px;">Object 336 —Medium fan speed</p> <p style="padding-left: 40px;">Object 337 —High fan speed</p> <p style="padding-left: 40px;">Object 338 —Fan speed off</p> <p>The object receives telegram “1”, activate corresponding fan speed, and and feedback to the APP display. When 1bit-off object is not enable, fan speed off when telegram values of low/medium/high fan speed are “0”;</p> <p>When 1bit-off object is enable, fan speed off when 1bit-off object receives telegram “1”, and fan speed also off when telegram values of low/medium/high fan speed are “0”</p> <p>1byte: the corresponding telegram value of each fan speed is defined by the parameter. When object 334 receives the corresponding value, update the fan speed status on the APP display.</p>					



339	Fan automatic operation, status	KNX: {{Channel1}}	1bit	C,W	1.003 enable
<p>The communication object is used to receive feedback status of fan automatic control. Telegrams:</p> <p>1—Automatic</p> <p>0—Cancel automatic</p>					

Table 6.2.3 Room temperature unit function communication object table

### 6.2.4. Communication Object of Ventilation system

Numb	Name	Object Function	Description	Group Address	Length	C	R	W	T	U	Data Type	Priority
311	KNX: Channel 1	Power on/off			1 bit	C	-	-	T	-	switch	Low
312	KNX: Channel 1	Fan speed			1 byte	C	-	-	T	-	percentage (0..100%)	Low
313	KNX: Channel 1	Fan speed low			1 bit	C	-	-	T	-	switch	Low
314	KNX: Channel 1	Fan speed medium			1 bit	C	-	-	T	-	switch	Low
315	KNX: Channel 1	Fan speed high			1 bit	C	-	-	T	-	switch	Low
316	KNX: Channel 1	Fan automatic operation			1 bit	C	-	-	T	-	enable	Low
317	KNX: Channel 1	Heat recovery			1 bit	C	-	-	T	-	enable	Low
318	KNX: Channel 1	Power on/off, status			1 bit	C	-	W	-	-	switch	Low
319	KNX: Channel 1	Fan speed, status			1 byte	C	-	W	-	-	percentage (0..100%)	Low
320	KNX: Channel 1	Fan speed low, status			1 bit	C	-	W	-	-	switch	Low
321	KNX: Channel 1	Fan speed medium, status			1 bit	C	-	W	-	-	switch	Low
322	KNX: Channel 1	Fan speed high, status			1 bit	C	-	W	-	-	switch	Low
323	KNX: Channel 1	Fan automatic operation, status			1 bit	C	-	W	-	-	enable	Low
324	KNX: Channel 1	Heat recovery, status			1 bit	C	-	W	-	-	enable	Low
325	KNX: Channel 1	Filter alarm, status			1 bit	C	-	W	-	-	alarm	Low

Ventilation system

Fig.6.2.4 Ventilation system function communication object

NO.	Object Function	Name	Data Type	Flag	DPT
311	Power on/off	KNX: {{Channel1}}	1bit	C,T	1.001 switch
<p>The communication object is used to control ventilation power on/off via the APP, and send the telegram value to the bus. Telegrams:</p> <p>1—On</p> <p>0—Off</p>					
312	Fan speed	KNX: {{Channel1}}	1byte	C,T	5.001 percentage 5.100 fan stage
313	Fan speed low	KNX: {{Channel1}}	1bit	C,T	1.001 switch
314	Fan speed medium	KNX: {{Channel1}}	1bit	C,T	1.001 switch
315	Fan speed high	KNX: {{Channel1}}	1bit	C,T	1.001 switch
<p>These communication objects are used to send the control telegrams of fan speed to the bus.</p> <p>1byte: the corresponding telegram value of each fan speed is defined by the parameter. Activate the corresponding fan speed on the APP, and object 312 sends the corresponding telegram value of the fan speed to the bus.</p> <p>1bit:</p> <p>Object 313—Low fan speed</p> <p>Object 314—Medium fan speed</p> <p>Object 315—High fan speed</p> <p>The corresponding object sends telegram “1” to activate corresponding fan speed on the APP. Turn off fan speed when send telegram “0”.</p>					

<b>316</b>	<b>Fan automatic operation</b>	<b>KNX: {{Channel1}}</b>	<b>1bit</b>	<b>C,T</b>	<b>1.003 enable</b>
<p>The communication object is used to send the telegram of fan automatic control to the bus. Telegrams:</p> <p style="padding-left: 40px;">1— Auto</p> <p style="padding-left: 40px;">0— Exit auto</p>					
<b>317</b>	<b>Heat recovery</b>	<b>KNX: {{Channel1}}</b>	<b>1bit</b>	<b>C,T</b>	<b>1.003 enable</b>
<p>The communication object is used to control heat recovery mode via the APP, and send telegram to the bus. Telegrams:</p> <p style="padding-left: 40px;">1— Active</p> <p style="padding-left: 40px;">0— Inactive</p>					
<b>318</b>	<b>Power on/off, status</b>	<b>KNX: {{Channel1}}</b>	<b>1bit</b>	<b>C,W</b>	<b>1.001 switch</b>
<p>The communication object is used to receive the power on/off telegram of ventilation from the bus, and feedback to the APP display. Telegrams:</p> <p style="padding-left: 40px;">1— On</p> <p style="padding-left: 40px;">0— Off</p>					
<b>319</b>	<b>Fan speed, status</b>	<b>KNX: {{Channel1}}</b>	<b>1byte</b>	<b>C,W</b>	<b>5.001 percentage</b> <b>5.100 fan stage</b>
<b>320</b>	<b>Fan speed low, status</b>	<b>KNX: {{Channel1}}</b>	<b>1bit</b>	<b>C,W</b>	<b>1.001 switch</b>
<b>321</b>	<b>Fan speed medium, status</b>	<b>KNX: {{Channel1}}</b>	<b>1bit</b>	<b>C,W</b>	<b>1.001 switch</b>
<b>322</b>	<b>Fan speed high, status</b>	<b>KNX: {{Channel1}}</b>	<b>1bit</b>	<b>C,W</b>	<b>1.001 switch</b>
<p>These communication objects are used to receive status feedback to control fan speed via three 1bit objects or a 1byte object.</p> <p>1byte: the corresponding telegram value of each fan speed is defined by the parameter. When object 319 receives the corresponding value, update the fan speed status on the APP display.</p> <p>1bit :</p> <p style="padding-left: 40px;">Object 320— Low fan speed</p> <p style="padding-left: 40px;">Object 321— Medium fan speed</p> <p style="padding-left: 40px;">Object 322— High fan speed</p> <p>The object receives telegram “1”, activate corresponding fan speed, and feedback to the APP display. All telegram values of fan speed should be 0 when turn off fan speed;</p>					

<b>323</b>	<b>Fan automatic operation, status</b>	<b>KNX: {{Channel1}}</b>	<b>1bit</b>	<b>C,W</b>	<b>1.003 enable</b>
<p>The communication object is used to receive feedback status of fan automatic control. Telegrams:</p> <p style="padding-left: 40px;">1—Automatic</p> <p style="padding-left: 40px;">0—Cancel automatic</p>					
<b>324</b>	<b>Heat recovery, status</b>	<b>KNX: {{Channel1}}</b>	<b>1bit</b>	<b>C,W</b>	<b>1.003 enable</b>
<p>The communication object is used to receive status of heat recovery mode, and feedback to the APP display. Telegrams:</p> <p style="padding-left: 40px;">1—Active</p> <p style="padding-left: 40px;">0—Inactive</p>					
<b>325</b>	<b>Filteralarm, status</b>	<b>KNX: {{Channel1}}</b>	<b>1bit</b>	<b>C,W</b>	<b>1.005 alarm</b>
<p>The communication object is used to receive filter status from the bus, and feedback to the APP display. Telegrams:</p> <p style="padding-left: 40px;">1—In normal use</p> <p style="padding-left: 40px;">0—Replace alarm</p>					

Table 6.2.4 Ventilation system function communication object table

### 6.2.5. Communication Object of Audio control

Numb	Name	Object Function	Description	Group Address	Length	C	R	W	T	U	Data Type	Priority
312	KNX: Channel 1	Play=1/Pause=0			1 bit	C	-	-	T	-	start/stop	Low
313	KNX: Channel 1	Next track=1/Previous track=0			1 bit	C	-	-	T	-	step	Low
314	KNX: Channel 1	Volume+=1/Volume-=0			1 bit	C	-	-	T	-	step	Low
315	KNX: Channel 1	Absolute volume			1 byte	C	-	-	T	-	percentage (0..100%)	Low
316	KNX: Channel 1	Mute			1 bit	C	-	-	T	-	enable	Low
317	KNX: Channel 1	Play mode			1 byte	C	-	-	T	-	counter pulses (0..255)	Low
319	KNX: Channel 1	Play=1/Pause=0, status			1 bit	C	-	W	T	U	start/stop	Low
320	KNX: Channel 1	Absolute volume, status			1 byte	C	-	W	T	U	percentage (0..100%)	Low
321	KNX: Channel 1	Mute, status			1 bit	C	-	W	T	U	enable	Low
322	KNX: Channel 1	Play mode, status			1 byte	C	-	W	T	U	counter pulses (0..255)	Low

#### Audio control

Numb	Name	Object Function	Description	Group Address	Length	C	R	W	T	U	Data Type	Priority
311	KNX: Channel 1	Power on/off			1 bit	C	-	-	T	-	switch	Low
312	KNX: Channel 1	Play=1/Pause=0			1 bit	C	-	-	T	-	start/stop	Low
313	KNX: Channel 1	Next track=1/Previous track=0			1 bit	C	-	-	T	-	step	Low
314	KNX: Channel 1	Volume+=1/Volume-=0			1 bit	C	-	-	T	-	step	Low
317	KNX: Channel 1	Play mode			1 byte	C	-	-	T	-	counter pulses (0..255)	Low
318	KNX: Channel 1	Power on/off, status			1 bit	C	-	W	-	-	switch	Low
319	KNX: Channel 1	Play=1/Pause=0, status			1 bit	C	-	W	-	-	start/stop	Low
322	KNX: Channel 1	Play mode, status			1 byte	C	-	W	-	-	counter pulses (0..255)	Low

#### Audio control(with on/off)

Fig.6.2.5 Audio control function communication object

**Note: If “Audio control(with on/off)” is selected, default as power off when voltage recovery, and the object no need to send read request telegram. If “Audio control” is selected, the object needs to send read request telegram when voltage recovery.**

NO.	Object Function	Name	Data Type	Flag	DPT
311	Power on/off	KNX: {{Channel1}}	1bit	C,T	1.001 switch
<p>The communication object only applies to the audio control with power on/off. Used to to control the audio power on/off via the APP, and send the telegram to the bus. Telegrams:</p> <p style="padding-left: 40px;">1— On 0— Off</p>					
312	Play=1/Pause=0	KNX: {{Channel1}}	1bit	C,T	1.010 start/stop
<p>The communication object is used to play/stop the music in the audio module via the APP. Telegrams:</p> <p style="padding-left: 40px;">1— Play music 0— Pause playing music</p>					
313	Next track=1/Previous track=0	KNX: {{Channel1}}	1bit	C,T	1.007 step
<p>The communication object is used to switch the playing song of the audio module via the APP, to switch the previous song/the next song. Telegrams:</p> <p style="padding-left: 40px;">1— Play the next song 0— Play the previous song</p>					
314	Volume+=1/Volume-=0	KNX: {{Channel1}}	1bit	C,T	1.007 step
315	Absolute volume	KNX: {{Channel1}}	1byte	C,T	5.001 percentage 5.004 percentage
<p>The communication object is used to adjust volume of the audio module via the APP. Telegram value is determined by different object datatype.</p> <p>1 bit object, telegrams:</p> <p style="padding-left: 40px;">1— Increase volume 0— Decrease volume</p> <p>1 byte object only applies to the audio control function without power on/off. Telegram value is according to object type: 0..100 / 0..255</p>					
316	Mute	KNX: {{Channel1}}	1bit	C,T	1.003 enable
<p>The communication object only applies to the audio control function without power on/off, used to control mute of the audio module via the APP. Telegrams:</p> <p style="padding-left: 40px;">1— Mute 0— Cancel mute</p>					

317	Play mode	KNX: {{Channel1}}	1byte	C,T	5.010 counter pulses
<p>The communication object is used to send control telegram of the audio module play mode, different mode telegrams are preset by parameters.</p>					
318	Power on/off, status	KNX: {{Channel1}}	1bit	C,W	1.001 switch
<p>The communication object only applies to the audio control function with power on/off. Used to receive the power on/off telegram of the audio module from the bus.</p>					
319	Play=1/Pause=0, status	KNX: {{Channel1}}	1bit	C,W C,W,T,U	1.010 start/stop
<p>The communication object is used to receive the music play/stop status from the bus.</p> <p>When the audio control function with power on/off, the object flag is C,W; And without power on/off, the object flag is C,W,T,U.</p>					
320	Absolute volume, status	KNX: {{Channel1}}	1byte	C,W,T,U	5.001 percentage 5.004 percentage
<p>Volume adjustment function, 1byte object only applies to the audio control function without power on/off. Used to receive the volume status of audio control.</p> <p>Telegram value is according to object type: 0..100 / 0..255</p>					
321	Mute, status	KNX: {{Channel1}}	1bit	C,W,T,U	1.003 enable
<p>The communication object only applies to the audio control function without power on/off. Used to receive the mute status of audio control.</p>					
322	Play mode, status	KNX: {{Channel1}}	1byte	C,W C,W,T,U	5.010 counter pulses
<p>The communication object is used to receive the play mode status of the audio module from the bus, different mode telegrams are preset by parameters.</p> <p>When the audio control function with power on/off, the object flag is C,W; And without power on/off, the object flag is C,W,T,U.</p>					

Table 6.2.5 Audio control function communication object table

## 6.2.6. Communication Object of sensor function

Num	Name	Object Function	Description	Group Address	Length	C	R	W	T	U	Data Type	Priority
311	KNX: Channel 1	PM2.5 value			2 bytes	C	-	W	T	U	pulses	Low
312	KNX: Channel 1	PM10 value			2 bytes	C	-	W	T	U	pulses	Low
313	KNX: Channel 1	VOC value			2 bytes	C	-	W	T	U	pulses	Low
314	KNX: Channel 1	CO2 value			2 bytes	C	-	W	T	U	pulses	Low
311	KNX: Channel 1	PM2.5 value			2 bytes	C	-	W	T	U	concentration (µg/m³)	Low
312	KNX: Channel 1	PM10 value			2 bytes	C	-	W	T	U	concentration (µg/m³)	Low
313	KNX: Channel 1	VOC value			2 bytes	C	-	W	T	U	concentration (µg/m³)	Low
314	KNX: Channel 1	CO2 value			2 bytes	C	-	W	T	U	parts/million (ppm)	Low
315	KNX: Channel 1	AQI value			2 bytes	C	-	W	T	U	pulses	Low
316	KNX: Channel 1	Temperature value			2 bytes	C	-	W	T	U	temperature (°C)	Low
317	KNX: Channel 1	Humidity value			2 bytes	C	-	W	T	U	humidity (%)	Low
Air quality sensor												
Num	Name	Object Function	Description	Group Address	Length	C	R	W	T	U	Data Type	Priority
314	KNX: Channel 1	CO2 value			2 bytes	C	-	W	T	U	pulses	Low
314	KNX: Channel 1	CO2 value			2 bytes	C	-	W	T	U	parts/million (ppm)	Low
316	KNX: Channel 1	Temperature value			2 bytes	C	-	W	T	U	temperature (°C)	Low
317	KNX: Channel 1	Humidity value			2 bytes	C	-	W	T	U	humidity (%)	Low
CO2 sensor												
Num	Name	Object Function	Description	Group Address	Length	C	R	W	T	U	Data Type	Priority
311	KNX: Channel 1	PM2.5 value			2 bytes	C	-	W	T	U	pulses	Low
311	KNX: Channel 1	PM2.5 value			2 bytes	C	-	W	T	U	concentration (µg/m³)	Low
316	KNX: Channel 1	Temperature value			2 bytes	C	-	W	T	U	temperature (°C)	Low
317	KNX: Channel 1	Humidity value			2 bytes	C	-	W	T	U	humidity (%)	Low
PM2.5 sensor												
Num	Name	Object Function	Description	Group Address	Length	C	R	W	T	U	Data Type	Priority
313	KNX: Channel 1	VOC value			2 bytes	C	-	W	T	U	pulses	Low
313	KNX: Channel 1	VOC value			2 bytes	C	-	W	T	U	concentration (µg/m³)	Low
316	KNX: Channel 1	Temperature value			2 bytes	C	-	W	T	U	temperature (°C)	Low
317	KNX: Channel 1	Humidity value			2 bytes	C	-	W	T	U	humidity (%)	Low
VOC sensor												
Num	Name	Object Function	Description	Group Address	Length	C	R	W	T	U	Data Type	Priority
311	KNX: Channel 1	Presence detector			1 bit	C	-	W	T	U	occupancy	Low
312	KNX: Channel 1	Brightness value(lux)			2 bytes	C	-	W	T	U	lux (Lux)	Low
312	KNX: Channel 1	Brightness value(lux)			2 bytes	C	-	W	T	U	brightness (lux)	Low
Presence sensor												
Num	Name	Object Function	Description	Group Address	Length	C	R	W	T	U	Data Type	Priority
311	KNX: Channel 1	Motion detector			1 bit	C	-	W	T	U	occupancy	Low
Motion sensor												
Num	Name	Object Function	Description	Group Address	Length	C	R	W	T	U	Data Type	Priority
312	KNX: Channel 1	Brightness value(lux)			2 bytes	C	-	W	T	U	lux (Lux)	Low
312	KNX: Channel 1	Brightness value(lux)			2 bytes	C	-	W	T	U	brightness (lux)	Low
Brightness sensor												
Num	Name	Object Function	Description	Group Address	Length	C	R	W	T	U	Data Type	Priority
311	KNX: Channel 1	I/O signal value			1 bit	C	-	W	T	U	switch	Low

I/O signal

Fig.6.2.6 Sensor function communication object

NO.	Object Function	Name	Data Type	Flag	DPT
311	PM2.5 value	KNX: {{Channel1}}	2byte	C,W,T,U	7.001 pulse 9.030 concentration(ug/m3)
<p>The communication object is used to receive the input of the PM2.5 value and get the corresponding value from the bus to be updated to the APP display in ug/m<sup>3</sup>.</p> <p>Range: 0~999ug/m<sup>3</sup>, object datatype is determined by the parameter setting.</p>					
312	PM10 value	KNX: {{Channel1}}	2byte	C,W,T,U	7.001 pulse 9.030 concentration(ug/m3)
<p>The communication object is used to receive the input of the PM10 value and get the corresponding value from the bus to be updated to the APP display in ug/m<sup>3</sup>.</p> <p>Range: 0~999ug/m<sup>3</sup>, object datatype is determined by the parameter setting.</p>					
313	VOC value	KNX: {{Channel1}}	2byte	C,W,T,U	7.001 pulse 9.030 concentration(ug/m3)
<p>The communication object is used to receive the input of the VOC value and get the corresponding value from the bus to be updated to the APP display in ug/m<sup>3</sup>.</p> <p>Range: 0~999ug/m<sup>3</sup>, object datatype is determined by the parameter setting.</p>					
314	CO2 value	KNX: {{Channel1}}	2byte	C,W,T,U	7.001 pulse 9.008 parts/million(ppm)
<p>The communication object is used to receive the input of the CO2 value and get the corresponding value from the bus to be updated to the APP display in ppm.</p> <p>Range: 0...4000ppm</p>					
316	AQI value	KNX: {{Channel1}}	2byte	C,W,T,U	7.001 pulses
<p>The communication object is used to receive the input of the AQI value and get the corresponding value from the bus to be updated to the APP display. Range: 0...500</p>					
317	Temperaturevalue	KNX: {{Channel1}}	2byte	C,W,T,U	9.001 temperature
<p>The communication object is used to receive the input of the temperature value and get the corresponding value from the temperature sensor on bus to be updated to the APP display. Range: -40...40°</p>					

<b>311</b>	<b>Humidity value</b>	<b>KNX: {{Channel1}}</b>	<b>2byte</b>	<b>C,W,T,U</b>	<b>9.007 humidity</b>
<p>The communication object is used to receive the input of the humidity value and get the corresponding value from the humidity sensor on bus to be updated to the APP display. Range: 0...100%</p>					
<b>312</b>	<b>Brightnessvalue(lux)</b>	<b>KNX: {{Channel1}}</b>	<b>2byte</b>	<b>C,W,T,U</b>	<b>7.013 brightness(lux)</b> <b>9.004 lux(lux)</b>
<p>The communication object is used to receive the input of the brightness value and get the corresponding value from the bus to be updated to the APP display in lux. Range: 0...65535lux , object datatype is determined by the parameter setting.</p>					
<b>311</b>	<b>Motion detector</b>	<b>KNX: {{Channel1}}</b>	<b>1bit</b>	<b>C,W,T,U</b>	<b>1.018 Occupancy</b>
<p>The communication object is used to receive the input of the 1bit presence signal. Telegram:</p> <p style="padding-left: 40px;">0— No one 1— Some one</p>					
<b>311</b>	<b>I/O signal value</b>	<b>KNX: {{Channel1}}</b>	<b>1bit</b>	<b>C,W,T,U</b>	<b>1.001 switch</b>
<p>The communication object is used to receive the input of the 1bit I/O signal. Telegram:</p> <p style="padding-left: 40px;">0— Open 1— Close</p>					

Table 6.2.6 Sensor function communication object table



### 6.2.7. Communication Object of current/energymetering

Numb	Name	Object Function	Description	Group Address	Length	C	R	W	T	U	Data Type	Priority
311	KNX: Channel 1	Current value			2 bytes	C	-	W	T	U	current (mA)	Low
313	KNX: Channel 1	Power value			2 bytes	C	-	W	T	U	power (kW)	Low
311	KNX: Channel 1	Current value			4 bytes	C	-	W	T	U	electric current (A)	Low
313	KNX: Channel 1	Power value			4 bytes	C	-	W	T	U	power (W)	Low

#### Currentmetering

Numb	Name	Object Function	Description	Group Address	Length	C	R	W	T	U	Data Type	Priority
311	KNX: Channel 1	Current value			2 bytes	C	-	W	T	U	current (mA)	Low
312	KNX: Channel 1	Voltage value			2 bytes	C	-	W	T	U	voltage (mV)	Low
313	KNX: Channel 1	Power value			2 bytes	C	-	W	T	U	power (kW)	Low
314	KNX: Channel 1	Energy value			4 bytes	C	-	W	T	U	active energy (Wh)	Low
311	KNX: Channel 1	Current value			4 bytes	C	-	W	T	U	electric current (A)	Low
312	KNX: Channel 1	Voltage value			4 bytes	C	-	W	T	U	electric potential (V)	Low
313	KNX: Channel 1	Power value			4 bytes	C	-	W	T	U	power (W)	Low
314	KNX: Channel 1	Energy value			4 bytes	C	-	W	T	U	active energy (kWh)	Low

#### Energy metering

Fig.6.2.7 Current/Energy metering function communication object

NO.	Object Function	Name	Data Type	Flag	DPT
311	Currentvalue	KNX: {{Channel1}}	2byte	C,W,T,U	7.012 current(mA)
			4byte		9.021 current(mA)
					14.019 electric current(A)
<p>The communication object is used to receive the current value from the bus, updated to the APP display. Object datatype is determined by the parameter setting.</p> <p>When 2byte int is selected, display range: 0...65535mA, step value is 1mA.</p> <p>When 2byte float is selected, display range: -670760...670760mA, step value is 0.01mA.</p> <p>When 4byte is selected, display range: -99999999.9 ...99999999.9A, step value is 0.1A.</p>					
312	Voltage value	KNX: {{Channel1}}	2byte	C,W,T,U	9.020 voltage(mV)
			4byte		14.027 electric potential(V)
<p>The communication object is used to receive the voltage value from the bus, updated to the APP display. Object datatype is determined by the parameter setting.</p> <p>When 2byte is selected, display range: -670760mV...670760mV, step value is 0.01mV.</p> <p>When 4byte is selected, display range: -99999999.9 ...99999999.9 V, step value is 0.1V.</p>					
313	Power value	KNX: {{Channel1}}	2byte	C,W,T,U	9.024 power(kW)
			4byte		14.056 power(W)
<p>The communication object is used to receive the power value from the bus, updated to the APP display. Object datatype is determined by the parameter setting.</p> <p>When 2byte is selected, display range: -670760kW...670760 kW, step value is 0.01 kW.</p> <p>When 4byte is selected, display range: -99999999.9 ...99999999.9 W, step value is 0.1W.</p>					

314	Energy value	KNX: {{Channel1}}	4byte	C,W,T,U	13.010 active energy(Wh)
					13.013 active energy(kWh)

The communication object is used to receive the energy value from the bus, updated to the APP display. Object datatype is determined by the parameter setting.

Display range: -2147483648...2147483647Wh, step value is 1Wh.

Display range: -2147483648...2147483647kWh, step value is 1kWh.

Table 6.2.7 Current/Energymetering function communication object table

### 6.3. “Zigbee Channel” Communication Object

Number	Name	Object Function	Description	Group Address	Length	C	R	W	T	U	Data Type	Priority
3712	Zigbee: Channel 1	VOC value			2 bytes	C	R	-	T	-	pulses	Low
3713	Zigbee: Channel 1	CO2 value			2 bytes	C	R	-	T	-	pulses	Low
3714	Zigbee: Channel 1	Formaldehyde value			2 bytes	C	R	-	T	-	pulses	Low
3712	Zigbee: Channel 1	VOC value			2 bytes	C	R	-	T	-	concentration (µg/m <sup>3</sup> )	Low
3713	Zigbee: Channel 1	CO2 value			2 bytes	C	R	-	T	-	parts/million (ppm)	Low
3714	Zigbee: Channel 1	Formaldehyde value			2 bytes	C	R	-	T	-	concentration (µg/m <sup>3</sup> )	Low
3715	Zigbee: Channel 1	Temperature value			2 bytes	C	R	-	T	-	temperature (°C)	Low
3716	Zigbee: Channel 1	Humidity value			2 bytes	C	R	-	T	-	humidity (%)	Low
Air quality sensor												
3715	Zigbee: Channel 1	Temperature value			2 bytes	C	R	-	T	-	temperature (°C)	Low
3716	Zigbee: Channel 1	Humidity value			2 bytes	C	R	-	T	-	humidity (%)	Low
Temperature and humidity sensor												
3710	Zigbee: Channel 1	Brightness(lux) value			2 bytes	C	R	-	T	-	brightness (lux)	Low
3710	Zigbee: Channel 1	Brightness(lux) value			2 bytes	C	R	-	T	-	lux (Lux)	Low
Brightness sensor												
3710	Zigbee: Channel 1	Gas concentration value			2 bytes	C	R	-	T	-	pulses	Low
3710	Zigbee: Channel 1	Gas concentration value			2 bytes	C	R	-	T	-	parts/million (ppm)	Low
3710	Zigbee: Channel 1	Gas concentration value			2 bytes	C	R	-	T	-	concentration (µg/m <sup>3</sup> )	Low
Gas sensor												
3710	Zigbee: Channel 1	Binary value			1 bit	C	R	-	T	-	switch	Low
3710	Zigbee: Channel 1	Binary value			1 bit	C	R	-	T	-	boolean	Low
3710	Zigbee: Channel 1	Alarm detect			1 bit	C	R	-	T	-	alarm	Low
3710	Zigbee: Channel 1	Presence detect			1 bit	C	R	-	T	-	occupancy	Low
3710	Zigbee: Channel 1	Window/door detect			1 bit	C	R	-	T	-	window/door	Low
I/O signal												
3710	Zigbee: Channel 1-1	Switch			1 bit	C	-	W	-	-	switch	Low
3711	Zigbee: Channel 1-2	Switch			1 bit	C	-	W	-	-	switch	Low
3712	Zigbee: Channel 1-3	Switch			1 bit	C	-	W	-	-	switch	Low
3713	Zigbee: Channel 1-1	Switch, status			1 bit	C	R	-	T	-	switch	Low
3714	Zigbee: Channel 1-2	Switch, status			1 bit	C	R	-	T	-	switch	Low
3715	Zigbee: Channel 1-3	Switch, status			1 bit	C	R	-	T	-	switch	Low
Switch												
3710	Zigbee: Channel 1	Switch			1 bit	C	-	W	-	-	switch	Low
3712	Zigbee: Channel 1	Brightness value			1 byte	C	-	W	-	-	percentage (0..100%)	Low
3713	Zigbee: Channel 1	Switch, status			1 bit	C	R	-	T	-	switch	Low
3715	Zigbee: Channel 1	Brightness, status			1 byte	C	R	-	T	-	percentage (0..100%)	Low
Switch/Dimming												

3710	Zigbee: Channel 1	Switch	1 bit	C - W - -	switch	Low
3712	Zigbee: Channel 1	RGB dimming value	3 bytes	C - W - -	RGB value 3x(0.255)	Low
3713	Zigbee: Channel 1	Switch, status	1 bit	C R - T -	switch	Low
3715	Zigbee: Channel 1	RGB brightness, status	3 bytes	C R - T -	RGB value 3x(0.255)	Low
RGB dimming						
3710	Zigbee: Channel 1	Switch	1 bit	C - W - -	switch	Low
3711	Zigbee: Channel 1	Color temperature value	2 bytes	C - W - -	absolute colour temperature (K)	Low
3712	Zigbee: Channel 1	Brightness value	1 byte	C - W - -	percentage (0..100%)	Low
3713	Zigbee: Channel 1	Switch, status	1 bit	C R - T -	switch	Low
3714	Zigbee: Channel 1	Color temperature, status	2 bytes	C R - T -	absolute colour temperature (K)	Low
3715	Zigbee: Channel 1	Brightness, status	1 byte	C R - T -	percentage (0..100%)	Low
Color temperature						
3710	Zigbee: Channel 1	Switch	1 bit	C R W T U	switch	Low
3711	Zigbee: Channel 1	Color temperature value	2 bytes	C - W - -	absolute colour temperature (K)	Low
3712	Zigbee: Channel 1	RGB dimming value	3 bytes	C - W - -	RGB value 3x(0.255)	Low
3713	Zigbee: Channel 1	Brightness value	1 byte	C - W - -	percentage (0..100%)	Low
3714	Zigbee: Channel 1	Color temperature, status	2 bytes	C R - T -	absolute colour temperature (K)	Low
3715	Zigbee: Channel 1	RGB brightness, status	3 bytes	C R - T -	RGB value 3x(0.255)	Low
3716	Zigbee: Channel 1	Brightness, status	1 byte	C R - T -	percentage (0..100%)	Low
RGBCW						
3710	Zigbee: Channel 1-1	Open/Close	1 bit	C - W - -	open/close	Low
3711	Zigbee: Channel 1-1	Stop	1 bit	C - W - -	step	Low
3712	Zigbee: Channel 1-1	Curtain position & status	1 byte	C R W T -	percentage (0..100%)	Low
3713	Zigbee: Channel 1-2	Open/Close	1 bit	C - W - -	open/close	Low
3714	Zigbee: Channel 1-2	Stop	1 bit	C - W - -	step	Low
3715	Zigbee: Channel 1-2	Curtain position & status	1 byte	C R W T -	percentage (0..100%)	Low
Curtain position						
3710	Zigbee: Channel 1	Brightness(lux) value	2 bytes	C R - T -	lux (Lux)	Low
3715	Zigbee: Channel 1	Temperature value	2 bytes	C R - T -	temperature (°C)	Low
3716	Zigbee: Channel 1	Humidity value	2 bytes	C R - T -	humidity (%)	Low
Temperature, humidity and brightness sensor						

Fig.6.3 "Zigbee Channel" communication object

NO.	Object Function	Name	Data Type	Flag	DPT
3712	VOC value	Zigbee: {{Channel1}}	2byte	C,R,T	7.001 pulse 9.030 concentration(ug/m3)
<p>The communication object applies to air quality sensor, is used to send the VOC value in ug/m<sup>3</sup> to the KNX bus. Range: 0...999ug/m<sup>3</sup>, object datatype is determined by the parameter setting.</p>					
3713	CO2 value	Zigbee: {{Channel1}}	2byte	C,R,T	7.001 pulse 9.008 parts/million(ppm)
<p>The communication object applies to air quality sensor, is used to send the CO2 value in ppm to the KNX bus.</p> <p>Range: 0...4000ppm</p>					
3714	Formaldehydevalue	Zigbee: {{Channel1}}	2byte	C,R,T	7.001 pulse 9.030 concentration(ug/m3)
<p>The communication object applies to air quality sensor, is used to send the formaldehyde value in ug/m<sup>3</sup> to the KNX bus. Range: 0...1000 ug/m<sup>3</sup></p>					

3715	Temperaturevalue	Zigbee: {{Channel1}}	2byte	C,R,T	9.001 temperature
The communication object applies to temperature sensor, and temperature, humidity and brightness sensor, is used to send the temperaturevalue in °C to the KNX bus. Range: -50...99°C					
3716	Humidity value	Zigbee: {{Channel1}}	2byte	C,R,T	9.007 humidity
The communication object applies to humidity sensor, and temperature, humidity and brightness sensor, air quality sensor, is used to send the humidity value in % to the KNX bus. Range: 0...100%					
3710	Brightness(lux)value	Zigbee: {{Channel1}}	2byte	C,R,T	7.013 brightness(lux) 9.004 lux(lux)
The communication object applies to brightness sensor, and temperature, humidity and brightness sensor, air quality sensor, is used to send the brightness value to the KNX bus. Range: 0...65535lux, object datatype is determined by the parameter setting.					
3710	Gas concentration value	Zigbee: {{Channel1}}	2byte	C,R,T	7.001 pulse 9.008 parts/million(ppm) 9.030 concentration(ug/m3)
The communication object applies to gas sensor, air quality sensor, gas measurement, is used to send the gas concentration value to the KNX bus. For example VOC, CO2 or formaldehyde detection value.					
3710	Binaryvalue	Zigbee: {{Channel1}}	1bit	C,R,T	1.001 switch 1.002 boolean
3710	Alarmdetect	Zigbee: {{Channel1}}	1bit	C,R,T	1.005 alarm
3710	Presence detect	Zigbee: {{Channel1}}	1bit	C,R,T	1.018 occupancy
3710	Window/door detect	Zigbee: {{Channel1}}	1bit	C,R,T	1.019 window/door
The communication object applies to I/O type sensor, is used to send the I/O signal to the KNX bus. Object datatype is determined by the parameter setting. Telegram value: 0—Open/No alarm/Not occupied/Close window 1—Close/Alarm/Occupied/Open window					
3710/. ./ 3712	Switch	Zigbee: {{Channel1}}	1bit	C,W C,W,R,T,U	1.001 switch
3713/. ./ 3715	Switch, status	Zigbee: {{Channel1}}	1bit	C,R,T	1.001 switch

These communication objects apply to switch, dimming, RGB, color temperature and RGBCW control, are used for KNX system to control Zigbee lamps, including lamp, dimmable lamp, RGB bulb/strip, color temperature light and RGBCW bulb.

When "Switch" is selected, object name is "Zigbee: {{Channel1}}-x", and set the number of channels for the switch by parameter, up to 3 channels, x=1/2/3.

Telegram value:

0—Turn off the light

1—Turn on the light

Obj.3710/./3712: Used for receiving On/Off telegram from KNX bus, to control the light on/off.

When "RGBCW" is selected, object flag is C,W,R,T,U; while other selections, the object flag is C,W.

Obj.3713/./3715: Used for sending On/Off status to the bus.

<b>3712</b>	<b>Brightness value</b>	<b>Zigbee: {{Channel1}}</b>	<b>1byte</b>	<b>C,W</b>	<b>5.001 percentage(0..100%)</b>
<b>3715</b>	<b>Brightness, status</b>	<b>Zigbee: {{Channel1}}</b>	<b>1byte</b>	<b>C,R,T</b>	<b>5.001 percentage(0..100%)</b>

These two communication objects apply to color temperature and RGBCW control, are used for KNX system to control Zigbee lamps, including RGB bulb/strip and RGBCW bulb. Telegrams: 0...100%

Obj.3712: Used for receiving the brightness value from KNX bus, to control the brightness of the lamp.

Obj.3715: Used for sending the brightness status to KNX bus.

<b>3712</b>	<b>RGB dimming value</b>	<b>Zigbee: {{Channel1}}</b>	<b>3byte</b>	<b>C,W</b>	<b>232.600 RGB value 3x(0..255)</b>
<b>3715</b>	<b>RGB brightness, status</b>	<b>Zigbee: {{Channel1}}</b>	<b>3byte</b>	<b>C,R,T</b>	<b>232.600 RGB value 3x(0..255)</b>

These two communication objects apply to RGB and RGBCW control, are used for KNX system to control Zigbee lamps, including RGB bulb/strip and RGBCW bulb.

Obj.3712: Used for receiving the brightness value of RGB three-color lamp from KNX bus, to control the color of the lamp.

Obj.3715: Used for sending the brightness status of RGB three-color lamp to the KNX bus.

3-Byte Code for RGB Dimming Object Data Type: U8 U8 U8, as follows:

3 <sub>MSB</sub>	2	1 <sub>LSB</sub>
R	G	B
UUUUUUUU	UUUUUUUU	UUUUUUUU

R: red dimming value; G: green dimming value; B: blue dimming value.

<b>3711</b>	<b>Color temperature value</b>	<b>Zigbee: {{Channel1}}</b>	<b>2byte</b>	<b>C,W</b>	<b>7.600 absolute color temperature</b>
-------------	--------------------------------	-----------------------------	--------------	------------	---

3714	Color temperature, status	Zigbee: {{Channel1}}	2byte	C,R,T	7.600 absolute color temperature
<p>These two communication objects apply to color temperature and RGBCW control, are used for KNX system to control Zigbee lamps, including color temperature light and RGBCW bulb. Telegrams: 2000..7000 K</p> <p>Obj.371 1: Used for receiving the color temperature control value form the bus, to control the color temperature of the lamp.</p> <p>Obj.371 4: Used for sending the color temperature status to the KNX bus.</p>					
3710/ 3713	Open/Close	Zigbee: {{Channel1}}x	1bit	C,W	1.009 open/close
3711/ 3714	Stop	Zigbee: {{Channel1}}x	1bit	C,W	1.007 step
3712/ 3715	Curtain position & status	Zigbee: {{Channel1}}x	1byte	C,W,R,T	5.001 percentage
<p>These communication objects apply to curtain step/move, are used for KNX system to control Zigbee electric curtain. Set the number of channels for the curtain by parameter, up to 2 channels, x=1/2.</p> <p>Obj.3710/3713: Used for receiving the telegrams from KNX bus to control curtain open/close.</p> <p>Telegrams:</p> <p>1—Close the curtain 0—Open the curtain</p> <p>Obj.3711/3714: Used for receiving the telegrams from KNX bus to stop curtain movement.</p> <p>Telegrams:</p> <p>1—Stop</p> <p>Obj.3712/3715: Used for receiving the telegrams from KNX bus to control curtain position, and return the status to bus. Telegrams: 0..100%</p>					

Table 6.3 "Zigbee Channel" communication object table

## 6.4. “Room temperature controller” Communication Object

Numb	Name	Object Function	Description	Group Address	Length	C	R	W	T	U	Data Type	Priority
74	RTC 1	Power on/off			1 bit	C	-	W	-	-	switch	Low
75	RTC 1	Room temperature sensor			2 bytes	C	-	W	T	U	temperature (°C)	Low
76	RTC 1	Current setpoint adjustment			2 bytes	C	-	W	-	-	temperature (°C)	Low
77	RTC 1	Heating/Cooling mode			1 bit	C	-	W	-	-	cooling/heating	Low
78	RTC 1	Operation mode			1 byte	C	-	W	-	-	HVAC mode	Low
79	RTC 1	Comfort mode			1 bit	C	-	W	-	-	enable	Low
80	RTC 1	Economy mode			1 bit	C	-	W	-	-	enable	Low
81	RTC 1	Frost/Heat protection mode			1 bit	C	-	W	-	-	enable	Low
82	RTC 1	Standby mode			1 bit	C	-	W	-	-	enable	Low
83	RTC 1	Fan automatic operation			1 bit	C	-	W	-	-	enable	Low
84	RTC 1	Window contact			1 bit	C	-	W	-	U	window/door	Low
85	RTC 1	Presence detector			1 bit	C	-	W	-	U	occupancy	Low
86	RTC 1	Current temperature setpoint, status			2 bytes	C	R	-	T	-	temperature (°C)	Low
87	RTC 1	Heating/Cooling mode, status			1 bit	C	R	-	T	-	cooling/heating	Low
88	RTC 1	Operation mode, status			1 byte	C	R	-	T	-	HVAC mode	Low
89	RTC 1	Comfort mode, status			1 bit	C	R	-	T	-	enable	Low
90	RTC 1	Economy mode, status			1 bit	C	R	-	T	-	enable	Low
91	RTC 1	Frost/Heat protection mode, status			1 bit	C	R	-	T	-	enable	Low
92	RTC 1	Standby mode, status			1 bit	C	R	-	T	-	enable	Low
93	RTC 1	Heating control value, status			1 bit	C	R	-	T	-	switch	Low
94	RTC 1	Cooling control value, status			1 bit	C	R	-	T	-	switch	Low
95	RTC 1	Fan speed, status			1 byte	C	-	-	T	-	percentage (0..100%)	Low

Fig.6.4 “Room temperature controller” communication object

NO.	Object Function	Name	Data Type	Flag	DPT
<b>74</b>	<b>Power on/off</b>	<b>RTC 1</b>	<b>1bit</b>	<b>C,W</b>	<b>1.001 switch</b>
<p>The communication object is used to receive the telegram value of control RTC power on/off from the bus. Telegrams:</p> <p>1—On</p> <p>0—Off</p>					
<b>75</b>	<b>Room temperaturesensor</b>	<b>RTC 1</b>	<b>2byte</b>	<b>C,W,T,U</b>	<b>9.001 temperature</b>
<p>The communication object is used to receive the room temperature from the bus, and send read request cyclically, and also receive feedback.</p>					
<b>76</b>	<b>Currentsetpoint adjustment</b>	<b>RTC 1</b>	<b>2byte</b>	<b>C,W</b>	<b>9.001 temperature</b>
<p>The communication object is used to modify the currentsetpoint value of temperature. Telegrams: 0..65535</p>					
<b>77</b>	<b>Heating/Cooling mode</b>	<b>RTC 1</b>	<b>1bit</b>	<b>C,W</b>	<b>1.100 cooling/heating</b>
<p>The communication object is used to switch heating/cooling mode via the bus. Telegrams:</p> <p>1—Heating</p> <p>0—Cooling</p>					

78	Operation mode	RTC 1	1byte	C,W	20.102 HVAC mode
79	Comfort mode	RTC 1	1bit	C,W	1.003 enable
80	Economy mode	RTC 1	1bit	C,W	1.003 enable
81	Frost/Heat protection mode	RTC 1	1bit	C,W	1.003 enable
82	Standby mode	RTC 1	1bit	C,W	1.003 enable
<p>These communication objects are used to control RTC operation mode via the bus.</p> <p>1byte: object 78 is visible. Telegrams: 1-comfort, 2-standby, 3-economy, 4-protection, other reserved.</p> <p>1bit:</p> <p>Object 79— Comfort mode</p> <p>Object 80— Economy mode</p> <p>Object 81— Protection mode</p> <p>Object 82— Standby mode</p> <p>Activate corresponding mode when receive a telegram “1”. When 1bit standby mode is not enable, and objects value of comfort, economy and protection are all 0, it is standby mode. When 1bit standby mode is enable, the 1bit standby object receives 1 is standby mode, and telegram “0” will be ignored.</p>					
83	Fan automatic operation	RTC 1	1bit	C,W	1.003 enable
<p>The communication object is used to activate fan automatic control via the bus. Telegrams:</p> <p>1— Auto</p> <p>0— Exit auto</p>					
84	Window contact	RTC 1	1bit	C,W,U	1.019 Window/door
<p>The communication object is used to receive the switch status of window contact. Telegrams:</p> <p>1— Open window</p> <p>0— Close window</p>					
85	Presence detector	RTC 1	1bit	C,W,U	1.018 occupancy
<p>The communication object is used to receive the room occupancy status from presence detector. Telegrams:</p> <p>1— Occupied</p> <p>0— Not occupied</p>					
86	Current temperature setpoint, status	RTC 1	2byte	C,R,T	9.001 temperature
<p>The communication object is used to send the current setpoint temperature of RTC to the bus. Telegrams: 0..65535</p>					



87	Heating/Cooling mode, status	RTC 1	1bit	C,R,T	1.100 cooling/heating
<p>The communication object is used to feedback the telegram to the bus for switching heating and cooling function.</p>					
88	Operation mode, status	RTC 1	1byte	C,R,T	20.102 HVAC mode
89	Comfort mode, status	RTC 1	1bit	C,R,T	1.003 enable
90	Economy mode, status	RTC 1	1bit	C,R,T	1.003 enable
91	Frost/Heat protection mode, status	RTC 1	1bit	C,R,T	1.003 enable
92	Standby mode, status	RTC 1	1bit	C,R,T	1.003 enable
<p>These communication objects are used to send RTC operation mode status to the bus.            When 1 byte: object 88 is visible, telegrams: 1-comfort, 2-standby, 3-economy, 4-protection, other reserved.            When 1bit:                Object 89—Comfort mode                Object 90—Economy mode                Object 91—Protection mode                Object 92—Standby mode            When a mode is activated, the corresponding object only sends telegram "1". When 1 bit standby object is not enable, activate standby mode when comfort, economy, protection objects send telegram 0 together. When 1 bit standby object is enable, activate standby mode only when standby object send 1.</p> <p><b>Note: no requirement to send mode status to the bus when switchover via bus. The same is fan speed and other operation.</b></p>					
93	Heating control value, status	RTC 1	1bit 1byte	C,R,T	1.001 switch 5.001 percentage
94	Cooling control value, status	RTC 1	1bit 1byte	C,R,T	1.001 switch 5.001 percentage
<p>These communication objects are used to send control status of heating or cooling function to the bus. Object datatype is according to parameter setting.</p>					
94	Fan speed, status	RTC 1	1byte	C,T	5.001 percentage 5.100 fan stage
<p>The communication object is used to send the status of fan speed to the bus. The corresponding telegram value of each fan speed is defined by the parameter.</p>					

Table 6.4 "Room temperature controller" communication object table

## 6.5. “Ventilation controller” Communication Object

Numb	Name	Object Function	Description	Group Address	Length	C	R	W	T	U	Data Type	Priority
294	Ventilation controller	Fan automatic operation			1 bit	C	-	W	-	-	enable	Low
295	Ventilation controller	PM 2.5 value			2 bytes	C	-	W	T	U	pulses	Low
296	Ventilation controller	Fan speed, status			1 byte	C	-	-	T	-	percentage (0..100%)	Low
297	Ventilation controller	Fan speed low, status			1 bit	C	-	-	T	-	switch	Low
298	Ventilation controller	Fan speed medium, status			1 bit	C	-	-	T	-	switch	Low
299	Ventilation controller	Fan speed high, status			1 bit	C	-	-	T	-	switch	Low

Fig.6.5 “Ventilation controller” communication object

NO.	Object Function	Name	Data Type	Flag	DPT
294	Fan automatic operation	Ventilation controller	1bit	C,W	1.003 enable
<p>The communication object is used to activate fan automatic control via the bus. Telegrams:</p> <p>1—Auto</p> <p>0—Exit auto</p>					
295	PM 2.5 value VOC value CO2 value	Ventilation controller	2byte	C,W,T,U	7.001 pulse 9.030 concentration(ug/m <sup>3</sup> ) 9.008 parts/million(ppm)
<p>The communication object is used to receive the input value of PM2.5/VOC/CO2, and get the corresponding value from the bus and update it to the display, the corresponding object datatype is defined by the parameter. Unit is ug/m<sup>3</sup> or ppm. Range: 0~999ug/m<sup>3</sup> or 0...4000ppm</p> <p>For example, Control value of automatic operation is PM2.5, that is, under the automation, the ventilation system can adjust the fan speed automatically according to PM2.5 concentration.</p>					
296	Fan speed, status	Ventilation controller	1byte	C,T	5.001 percentage 5.100 fan stage
297	Fan speed low, status	Ventilation controller	1bit	C,T	1.001 switch
298	Fan speed medium, status	Ventilation controller	1bit	C,T	1.001 switch
299	Fan speed high, status	Ventilation controller	1bit	C,T	1.001 switch
<p>These communication objects are used to send control telegrams of the fan speed to the bus.</p> <p>1byte: the corresponding telegram value of each fan speed is defined by the parameter. Object 296 sends the corresponding telegram value of the fan speed to the bus.</p> <p>1bit:</p> <p>Object 297—Low fan speed</p> <p>Object 298—Medium fan speed</p> <p>Object 299—High fan speed</p> <p>The corresponding object sends telegram “1” to the bus, and sends telegram “0” is turn off fan speed.</p>					

Table 6.5 “Ventilation controller” communication object table

## 6.6. “Logic” Communication Object

### 6.6.1. “AND/OR/XOR” Communication Object

Numb	Name	Object Function	Description	Group Address	Length	C	R	W	T	U	Data Type	Priority
2	1st Logic	Input a			1 bit	C	-	W	T	U	boolean	Low
3	1st Logic	Input b			1 bit	C	-	W	T	U	boolean	Low
4	1st Logic	Input c			1 bit	C	-	W	T	U	boolean	Low
5	1st Logic	Input d			1 bit	C	-	W	T	U	boolean	Low
6	1st Logic	Input e			1 bit	C	-	W	T	U	boolean	Low
7	1st Logic	Input f			1 bit	C	-	W	T	U	boolean	Low
8	1st Logic	Input g			1 bit	C	-	W	T	U	boolean	Low
9	1st Logic	Input h			1 bit	C	-	W	T	U	boolean	Low
10	1st Logic	Logic result			1 bit	C	-	-	T	-	boolean	Low

Fig.6.6.1 “AND/OR/XOR” Communication Object

NO.	Object Function	Name	Data Type	Flag	DPT
2/...	<b>Input x</b>	<b>1st /.../8th Logic</b>	<b>1bit</b>	<b>C,W,T,U</b>	<b>1.002 boolean</b>
The communication object is used to receive the value of logical input Input x.					
10	<b>Logic result</b>	<b>1st /.../8th Logic</b>	<b>1bit</b>	<b>C,T</b>	<b>1.002 boolean</b>
The communication object is used to send the results of logical operation.					

Table 6.6.1 “AND/OR/XOR” communication object table

### 6.6.2. "Gate forwarding" Communication Object

Numb	Name	Object Function	Description	Group Address	Length	C	R	W	T	U	Data Type	Priority
2	1st Logic	Gate value select			1 byte	C	-	W	-	-	scene number	Low
3	1st Logic	Input A			1 bit	C	-	W	-	-	switch	Low
4	1st Logic	Input B			1 bit	C	-	W	-	-	switch	Low
5	1st Logic	Input C			1 bit	C	-	W	-	-	switch	Low
6	1st Logic	Input D			1 bit	C	-	W	-	-	switch	Low
7	1st Logic	Output A			1 bit	C	-	-	T	-	switch	Low
8	1st Logic	Output B			1 bit	C	-	-	T	-	switch	Low
9	1st Logic	Output C			1 bit	C	-	-	T	-	switch	Low
10	1st Logic	Output D			1 bit	C	-	-	T	-	switch	Low

Fig.6.6.2 "Gate forwarding" Communication Object

NO.	Object Function	Name	Data Type	Flag	DPT
<b>2</b>	<b>Gate value select</b>	<b>1st /.../8th Logic</b>	<b>1byte</b>	<b>C,W</b>	<b>17.001 scene number</b>
The communication object is used to select the scene of logical gate forwarding.					
<b>3/.../6</b>	<b>Input x</b>	<b>1st /.../8th Logic</b>	<b>1bit</b> <b>4bit</b> <b>1byte</b>	<b>C,W</b>	<b>1.001 switch</b> <b>3.007 dimming control</b> <b>5.010 counter pulses (0..255)</b>
The communication object is used to receive the value of the logic gate input Input x.					
<b>7/.../10</b>	<b>Output x</b>	<b>1st /.../8th Logic</b>	<b>1bit</b> <b>4bit</b> <b>1byte</b>	<b>C,T</b>	<b>1.001 switch</b> <b>3.007 dimming control</b> <b>5.010 counter pulses (0..255)</b>
The communication object is used to output the value forwarded by the logic gate. The output value is the same as the input value, but one input can be forwarded into one or more outputs, set by parameters.					

Table 6.6.2 "Gate forwarding" communication object table

### 6.6.3. “Threshold comparator” Communication Object

Numb	Name	Object Function	Description	Group Address	Length	C	R	W	T	U	Data Type	Priority
2	1st Logic	Threshold value input			4 bit	C	-	W	-	U	dimming control	Low
2	1st Logic	Threshold value input			1 byte	C	-	W	-	U	counter pulses (0..255)	Low
2	1st Logic	Threshold value input			2 bytes	C	-	W	-	U	pulses	Low
2	1st Logic	Threshold value input			4 bytes	C	-	W	-	U	counter pulses (unsigned)	Low
10	1st Logic	Logic result			1 bit	C	-	-	T	-	boolean	Low

Fig.6.6.3 “Threshold comparator” Communication Object

NO.	Object Function	Name	Data Type	Flag	DPT
2	Threshold value input	1st /.../8th Logic	4bit 1byte 2byte 4byte	C,W,U	3.007 dimming control 5.010 counter pulses(0..255) 7.001 pulses 12.001 counter pulses
The communication object is used to input threshold value.					
10	Logic result	1st /.../8th Logic	1bit	C,T	1.002 boolean
The communication object is used to send the results of logical operation. That is, the value that should be sent after the object input threshold is compared with the setting threshold value.					

Table 6.6.3 “Threshold comparator” communication object table

### 6.6.4. “Format convert” Communication Object

Numb	Name	Object Function	Description	Group Address	Length	C	R	W	T	U	Data Type	Priority
2	1st Logic	Input 1bit-bit0			1 bit	C	-	W	-	U	boolean	Low
3	1st Logic	Input 1bit-bit1			1 bit	C	-	W	-	U	boolean	Low
10	1st Logic	Output 2bit			2 bit	C	-	-	T	-	switch control	Low

“2x1bit -->1x2bit”function: converts two 1bit values to a 2bit value, such as Input bit1=1, bit0=0-->

Output 2bit=2

Numb	Name	Object Function	Description	Group Address	Length	C	R	W	T	U	Data Type	Priority
2	1st Logic	Input 1bit-bit0			1 bit	C	-	W	-	U	boolean	Low
3	1st Logic	Input 1bit-bit1			1 bit	C	-	W	-	U	boolean	Low
4	1st Logic	Input 1bit-bit2			1 bit	C	-	W	-	U	boolean	Low
5	1st Logic	Input 1bit-bit3			1 bit	C	-	W	-	U	boolean	Low
6	1st Logic	Input 1bit-bit4			1 bit	C	-	W	-	U	boolean	Low
7	1st Logic	Input 1bit-bit5			1 bit	C	-	W	-	U	boolean	Low
8	1st Logic	Input 1bit-bit6			1 bit	C	-	W	-	U	boolean	Low
9	1st Logic	Input 1bit-bit7			1 bit	C	-	W	-	U	boolean	Low
10	1st Logic	Output 1byte			1 byte	C	-	-	T	-	counter pulses (0..255)	Low

“8x1bit -->1x1byte”function: converts eight 1bit values to a 1byte value, such as Input bit2=1, bit1=1, bit0=1, other bits are 0-->Output 1byte=7

Numb	Name	Object Function	Description	Group Address	Length	C	R	W	T	U	Data Type	Priority
2	1st Logic	Input 1byte			1 byte	C	-	W	-	U	counter pulses (0..255)	Low
10	1st Logic	Output 2byte			2 bytes	C	-	-	T	-	pulses	Low

“1x1byte -->1x2byte”function: converts one 1byte values to a 2byte value, such as Input 1byte=125--> Output 2byte=125.Although the value remains the same, the data type of the value is different.

Numb	Name	Object Function	Description	Group Address	Length	C	R	W	T	U	Data Type	Priority
2	1st Logic	Input 1byte-low			1 byte	C	-	W	-	U	counter pulses (0..255)	Low
3	1st Logic	Input 1byte-high			1 byte	C	-	W	-	U	counter pulses (0..255)	Low
10	1st Logic	Output 2byte			2 bytes	C	-	-	T	-	pulses	Low

“2x1byte -->1x2byte”function: converts two 1byte values to a 2byte value, such as Input 1byte-low = 255 (\$FF), Input 1byte-high = 100 (\$64) -->Output 2byte = 25855 (\$64 FF)

Numb	Name	Object Function	Description	Group Address	Length	C	R	W	T	U	Data Type	Priority
2	1st Logic	Input 2byte-low			2 bytes	C	-	W	-	U	pulses	Low
3	1st Logic	Input 2byte-high			2 bytes	C	-	W	-	U	pulses	Low
10	1st Logic	Output 4byte			4 bytes	C	-	-	T	-	counter pulses (unsigned)	Low

“2x2byte -->1x4byte”function: converts two 2 byte values to a 4byte value, such as Input 2byte-low = 65530 (\$FF FA), Input 2byte-high = 32768 (\$80 00)-->Output 2byte = 2147549178 (\$80 00 FF FA)

Numb	Name	Object Function	Description	Group Address	Length	C	R	W	T	U	Data Type	Priority
2	1st Logic	Input 1byte			1 byte	C	-	W	-	U	counter pulses (0..255)	Low
3	1st Logic	Output 1bit-bit0			1 bit	C	-	-	T	-	boolean	Low
4	1st Logic	Output 1bit-bit1			1 bit	C	-	-	T	-	boolean	Low
5	1st Logic	Output 1bit-bit2			1 bit	C	-	-	T	-	boolean	Low
6	1st Logic	Output 1bit-bit3			1 bit	C	-	-	T	-	boolean	Low
7	1st Logic	Output 1bit-bit4			1 bit	C	-	-	T	-	boolean	Low
8	1st Logic	Output 1bit-bit5			1 bit	C	-	-	T	-	boolean	Low
9	1st Logic	Output 1bit-bit6			1 bit	C	-	-	T	-	boolean	Low
10	1st Logic	Output 1bit-bit7			1 bit	C	-	-	T	-	boolean	Low

“1x1byte -->8x1bit” function: converts one 1byte values to eight 1bit value, such as Input 1byte=200 --> Output bit0=0, bit1=0, bit2=0, bit3=1, bit4=0, bit5=0, bit6=1, bit7=1

Numb	Name	Object Function	Description	Group Address	Length	C	R	W	T	U	Data Type	Priority
2	1st Logic	Input 2byte			2 bytes	C	-	W	-	U	pulses	Low
9	1st Logic	Output 1byte-low			1 byte	C	-	-	T	-	counter pulses (0..255)	Low
10	1st Logic	Output 1byte-high			1 byte	C	-	-	T	-	counter pulses (0..255)	Low

“1x2byte -->2x1byte”function: converts one 2byte values to two 1byte value, such as Input 2byte = 55500 (\$D8 CC) -->Output 1byte-low = 204 (\$CC), Output 1byte-high =216 (\$D8)

Numb	Name	Object Function	Description	Group Address	Length	C	R	W	T	U	Data Type	Priority
2	1st Logic	Input 4byte			4 bytes	C	-	W	-	U	counter pulses (unsigned)	Low
9	1st Logic	Output 2byte-low			2 bytes	C	-	-	T	-	pulses	Low
10	1st Logic	Output 2byte-high			2 bytes	C	-	-	T	-	pulses	Low

“1x4byte --> 2x2byte”function: converts one 4byte values to two 2byte value, such as Input 4byte = 78009500 (\$04 A6 54 9C) -->Output 2byte-low = 21660 (\$54 9C), Output 2byte-high =1190 (\$04 A6)

Numb	Name	Object Function	Description	Group Address	Length	C	R	W	T	U	Data Type	Priority
2	1st Logic	Input 3byte			3 bytes	C	-	W	-	U	RGB value 3x(0..255)	Low
8	1st Logic	Output 1byte-low			1 byte	C	-	-	T	-	counter pulses (0..255)	Low
9	1st Logic	Output 1byte-middle			1 byte	C	-	-	T	-	counter pulses (0..255)	Low
10	1st Logic	Output 1byte-high			1 byte	C	-	-	T	-	counter pulses (0..255)	Low

“1x3byte -->3x1byte”function: converts one 3byte values to three 1byte value, such as Input 3byte = \$78 64 C8-->Output 1byte-low = 200 (\$C8) , Output 1byte-middle= 100 (\$64) , Output 1byte-high=120 (\$78)

Numb	Name	Object Function	Description	Group Address	Length	C	R	W	T	U	Data Type	Priority
2	1st Logic	Input 1byte-low			1 byte	C	-	W	-	U	counter pulses (0..255)	Low
3	1st Logic	Input 1byte-middle			1 byte	C	-	W	-	U	counter pulses (0..255)	Low
4	1st Logic	Input 1byte-high			1 byte	C	-	W	-	U	counter pulses (0..255)	Low
10	1st Logic	Output 3byte			3 bytes	C	-	-	T	-	RGB value 3x(0..255)	Low

“3x1byte -->1x3byte”function: converts three 1byte values to a 3byte value, such as Input 1byte-low = 150 (\$96), Input 1byte-middle= 100 (\$64), Input 1byte-high= 50 (\$32)-->Output 3byte = \$32 64 96

Fig.6.6.4 “Format convert” Communication Object

NO.	Object Function	Name	Data Type	Flag	DPT
2	Input ...	1st /.../8th Logic	1bit	C,W,U	1.001 switch
			1byte		5.010 counter pulses(0..255)
			2byte		7.001 pulses
			3byte		232.600 RGB value 3x(0..255)
			4byte		12.001 counter pulses
The communication object is used to input a value that needs to be converted.					
10	Output ...	1st /.../8th Logic	1bit	C,T	1.001 switch
			2bit		2.001 switch control
			1byte		5.010 counter pulses(0..255)
			2byte		7.001 pulses
			3byte		232.600 RGB value 3x(0..255)
4byte	12.001 counter pulses				
The communication object is used to output the converted value.					

Table 6.6.4 “Format convert” communication object table

### 6.6.5. "Gate function" Communication Object

Numb	Name	Object Function	Description	Group Address	Length	C	R	W	T	U	Data Type	Priority
2	1st Logic	Input			1 bit	C	-	W	-	-	switch	Low
3	1st Logic	Gate input			1 bit	C	-	W	-	-	boolean	Low
10	1st Logic	Output			1 bit	C	-	-	T	-	switch	Low
Input/Output - 1bit[On/Off]												
Numb	Name	Object Function	Description	Group Address	Length	C	R	W	T	U	Data Type	Priority
2	1st Logic	Input			1 byte	C	-	W	-	-	percentage (0..100%)	Low
3	1st Logic	Gate input			1 bit	C	-	W	-	-	boolean	Low
10	1st Logic	Output			1 byte	C	-	-	T	-	percentage (0..100%)	Low
Input/Output - 1byte[0..100%]												
Numb	Name	Object Function	Description	Group Address	Length	C	R	W	T	U	Data Type	Priority
2	1st Logic	Input			1 byte	C	-	W	-	-	counter pulses (0..255)	Low
3	1st Logic	Gate input			1 bit	C	-	W	-	-	boolean	Low
10	1st Logic	Output			1 byte	C	-	-	T	-	counter pulses (0..255)	Low
Input/Output - 1byte[0..255]												
Numb	Name	Object Function	Description	Group Address	Length	C	R	W	T	U	Data Type	Priority
2	1st Logic	Input			2 bytes	C	-	W	-	-	temperature (°C)	Low
3	1st Logic	Gate input			1 bit	C	-	W	-	-	boolean	Low
10	1st Logic	Output			2 bytes	C	-	-	T	-	temperature (°C)	Low
Input/Output - 2byte[Float]												
Numb	Name	Object Function	Description	Group Address	Length	C	R	W	T	U	Data Type	Priority
2	1st Logic	Input			2 bytes	C	-	W	-	-	pulses	Low
3	1st Logic	Gate input			1 bit	C	-	W	-	-	boolean	Low
10	1st Logic	Output			2 bytes	C	-	-	T	-	pulses	Low
Input/Output - 2byte[0..65535]												

Fig.6.6.5 "Gate function" Communication Object

NO.	Object Function	Name	Data Type	Flag	DPT
2	Input	1st /.../8th Logic	1bit	C,W	1.001 switch
			1byte		5.001 percentage
			2byte		5.010 counter pulses
					9.001 temperature
					7.001 pulses
The communication object is used to input a value that needs to gate filter.					
3	Gate input	1st /.../8th Logic	1bit	C,W	1.002 boolean
The communication object is used to control the switch status of gate input. Input signal is allowed to pass when gate open, then output, and the current input status is still sent if there is a change; Can not pass when gate close.					
10	Output	1st /.../8th Logic	bit	C,T	1.001 switch
			1byte		5.001 percentage
			2byte		5.010 counter pulses
					9.001 temperature
					7.001 pulses
The communication object is used to output the value after gate filtering. Only when gate input status is open, output is available, defined by the object "Gate input".					

Table 6.6.5 "Gate function" communication object table



### 6.6.6. “Delay function” Communication Object

Numb	Name	Object Function	Description	Group Address	Length	C	R	W	T	U	Data Type	Priority
2	1st Logic	Input			1 bit	C	-	W	-	-	switch	Low
10	1st Logic	Output			1 bit	C	-	-	T	-	switch	Low
Input/Output - 1bit[On/Off]												
Numb	Name	Object Function	Description	Group Address	Length	C	R	W	T	U	Data Type	Priority
2	1st Logic	Input			1 byte	C	-	W	-	-	percentage (0..100%)	Low
10	1st Logic	Output			1 byte	C	-	-	T	-	percentage (0..100%)	Low
Input/Output - 1byte[0..100%]												
Numb	Name	Object Function	Description	Group Address	Length	C	R	W	T	U	Data Type	Priority
2	1st Logic	Input			1 byte	C	-	W	-	-	counter pulses (0..255)	Low
10	1st Logic	Output			1 byte	C	-	-	T	-	counter pulses (0..255)	Low
Input/Output - 1byte[0..255]												
Numb	Name	Object Function	Description	Group Address	Length	C	R	W	T	U	Data Type	Priority
2	1st Logic	Input			2 bytes	C	-	W	-	-	temperature (°C)	Low
10	1st Logic	Output			2 bytes	C	-	-	T	-	temperature (°C)	Low
Input/Output - 2byte[Float]												
Numb	Name	Object Function	Description	Group Address	Length	C	R	W	T	U	Data Type	Priority
2	1st Logic	Input			2 bytes	C	-	W	-	-	pulses	Low
10	1st Logic	Output			2 bytes	C	-	-	T	-	pulses	Low
Input/Output - 2byte[0..65535]												

Fig.6.6.6 “Delay function” Communication Object

NO.	Object Function	Name	Data Type	Flag	DPT
2	Input	1st /.../8th Logic	1bit	C,W	1.001 switch
			1byte		5.001 percentage
			2byte		5.010 counter pulses
					9.001 temperature
The communication object is used to input a value that needs to delay.					
10	Output	1st /.../8th Logic	1bit	C,T	1.001 switch
			1byte		5.001 percentage
			2byte		5.010 counter pulses
					9.001 temperature
The communication object is used to output that needs to delay converted value, delay time is defined by the parameter.					

Table 6.6.6 “Delay function” communication object table

### 6.6.7. "Staircase lighting" Communication Object

Numb	Name	Object Function	Description	Group Address	Length	C	R	W	T	U	Data Type	Priority
2	1st Logic	Trigger value			1 bit	C	-	W	-	-	trigger	Low
3	1st Logic	Light-on duration time			2 bytes	C	-	W	-	-	time (s)	Low
10	1st Logic	Output			1 bit	C	-	-	T	-	switch	Low
10	1st Logic	Output			1 byte	C	-	-	T	-	counter pulses (0..255)	Low

Fig.6.6.7 "Staircase lighting" Communication Object

NO.	Object Function	Name	Data Type	Flag	DPT
2	Trigger value	1st /.../8th Logic	1bit	C,W	1.017 trigger
The communication object is used to receive the value to trigger staircase lighting.					
3	Light-on duration time	1st /.../8th Logic	2byte	C,W	7.005 time(s)
The communication object is used to modify the staircase light-on duration time, the modified range is referenced from the range defined by the parameter, take the limit value if exceeded.					
10	Output	1st /.../8th Logic	1bit 1byte	C,T	1.001 switch 5.010 counter pulses
The communication object is used to output value 1 when trigger, and send value 2 after duration time. Telegram value is determined by the parameter setting datatype.					

Table 6.6.7 "Staircase lighting" communication object table

## Chapter 7. UI Description for Tuya Smart APP

This chapter detail UI use for Tuya Smart APP in functional blocks. Please make sure the database is downloaded to KNX Gateway for Tuya ZigBee before operating APP. Once the database is downloaded, you can add gateways and other devices on the APP.

### 7.1.Add device

Click icon  on the mobile phone desk to start up Tuya Smart APP, register or login the account.

Click the icon  in the upper right corner of homepage to add device after login successfully. Take KNX Gateway for Tuya ZigBee as an example to explain the operation of adding a device.

Other devices are added in similar ways to the gateway, and no longer repeat in this chapter.

1. Select corresponding device type, KNX Gateway for Tuya ZigBee selects the Gateway in Gateway Control. You can select to add it manually(Step 2~5), or select to click icon  to auto scan, please ensure that the device has entered paring mode, click blue word in the follow picture to go to the details of "Auto Scan". If failed to auto add device, you can select to Try again or Add Manually.

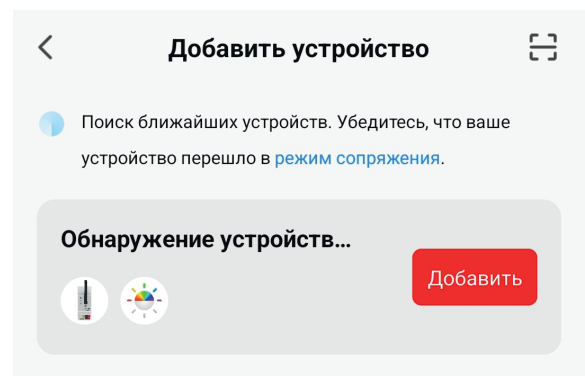
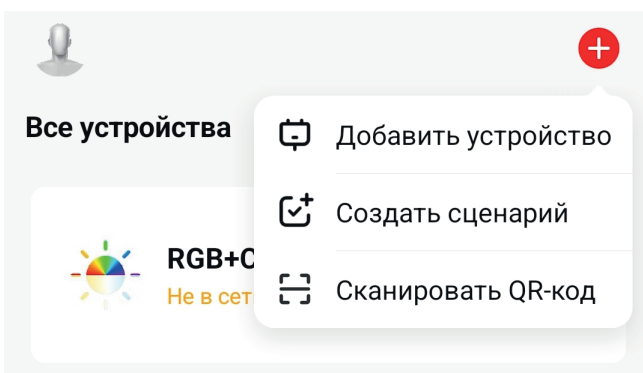

**Note: Please ensure to turn on Bluetooth, Wi-Fi and Location services, otherwise the APP cannot search the device, and display the following prompt:**

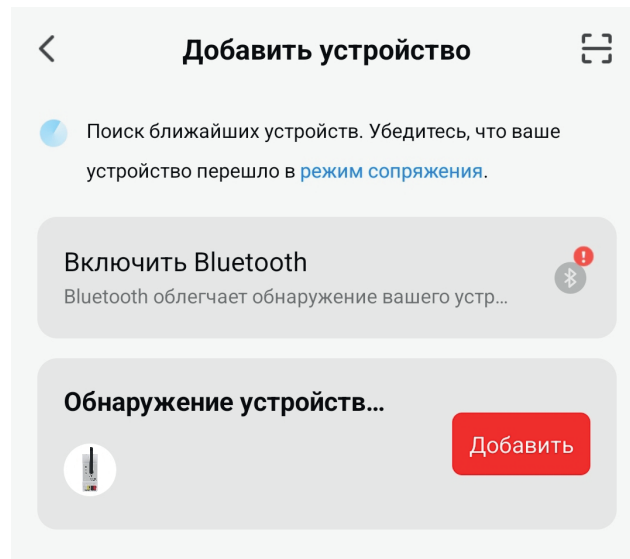

2. Click device icon, you can see the device connection steps. If the device is not reset, please perform net pairing as prompted. If it has been reset, ignore step 3. Please note the LED indication status on the gateway.

3. Reset device. Long press ZigBee connect button on the gateway for 5s, to remove the gateway from the cloud, triggered to flash after manually operating the connect button, and flashing 5 times to enter the waiting connection status. LED indication effect of gateway as follow:

LAN LED—Green LED:

—Always on after gateway network is connected OK, flashing when there is a data communication.

Connect status LED—Green LED:

—Off when gateway is connected to cloud;

—Always on when connection is waiting to connect;

—Always flashing when Tuya authorization code is abnormal(Unprogram).

4. Make sure the device reset is successful, and your phone and the gateway are under the same network. Then make sure the device LED is indicated correctly. The gateway confirms that the two green lights(Connect status LED and LAN LED) are always on, then click Next to enter the status for connecting device.

5. Add device. When scan the “KNXGateway”, click the icon  to complete the addition.

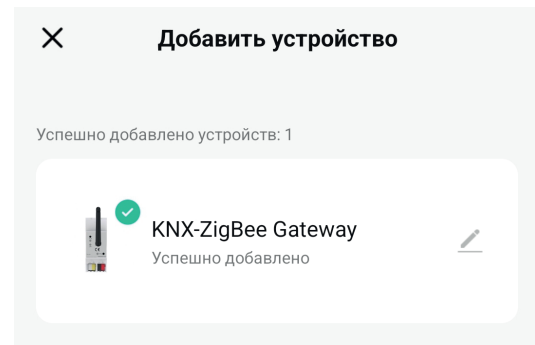
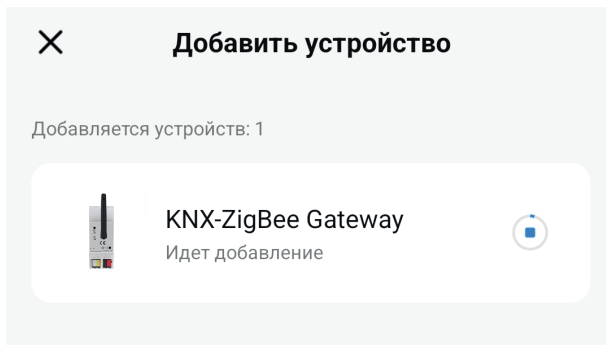

**Note: For Android systems, if the gateway fails to connect several times, it need to clear cache.**

Click icon  in the upper right corner of **【Me】** interface to enter the settings page, select **【Clear Cache】** .

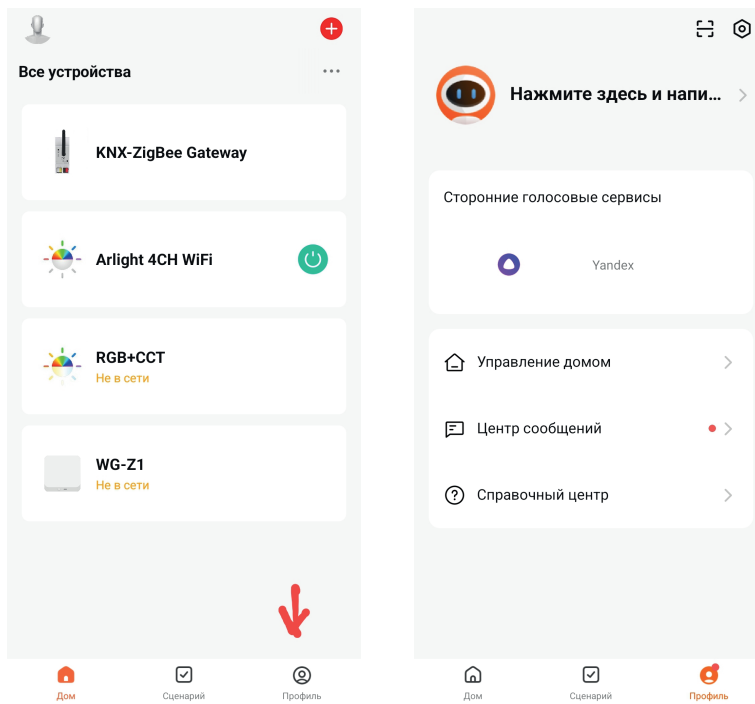

6. After completing the above steps, display setting page of the device, and displays a list of the added subdevices. Click “Add subdevice” to search device for addition.

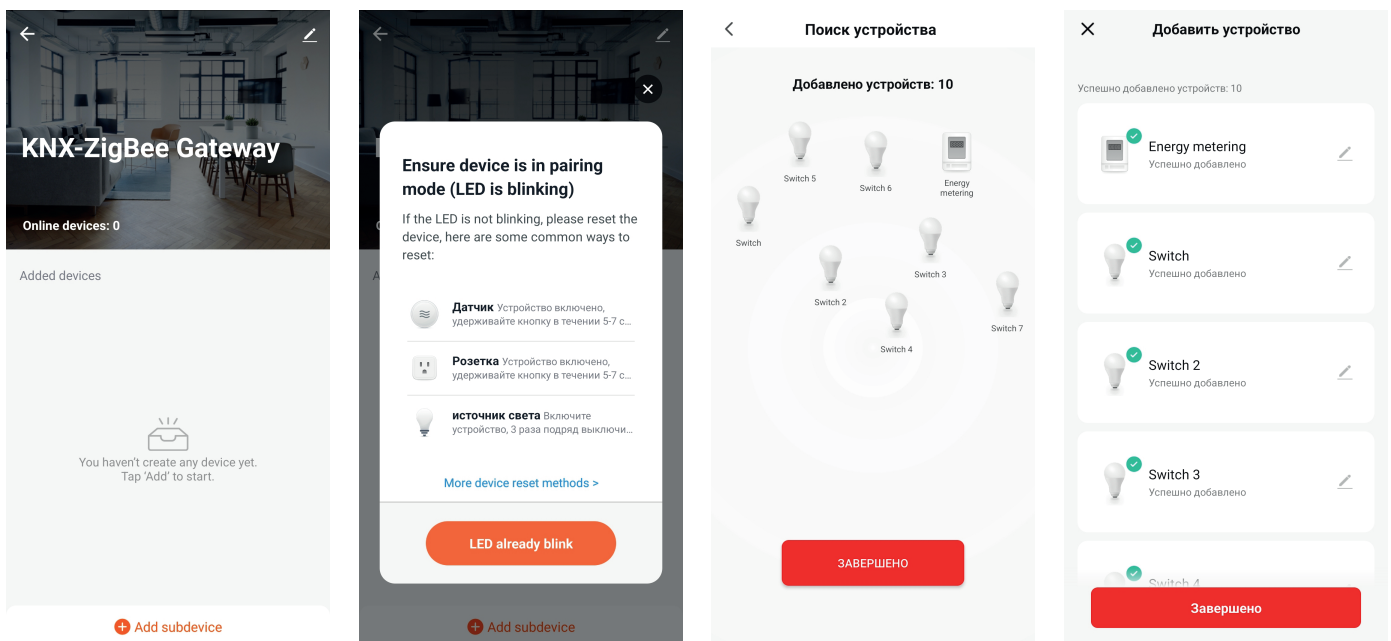

As below, the interactive use of KNX channel devices will be described in detail.

## 7.2. Device information

Click the icon  to check the Gateway information, which is shown in the figure below. The last bit is hidden from the IP address.

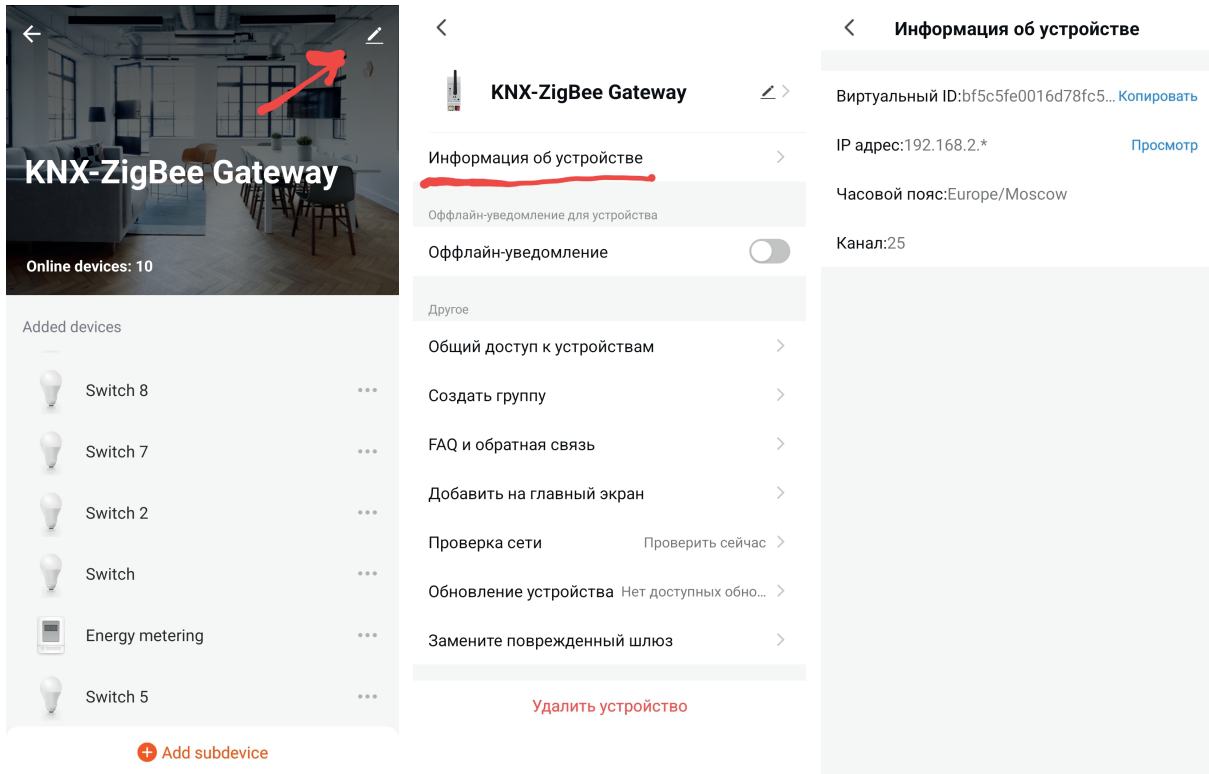

If you want to use IP address, when IP assignment is set as **Fixed mode**, IP address is assigned from the parameters on ETS; while IP assignment is **DHCP mode**, at first, you should enter the background of the router which is connected to the gateway, then you can see IP address of the gateway. (The ways to enter the router background are different, detail please refer to the router manual.)

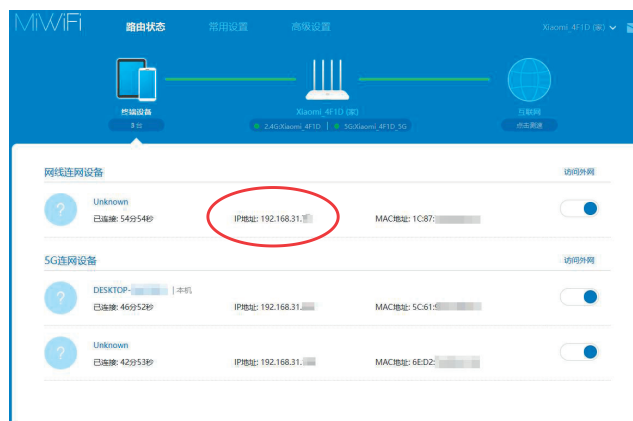

### 7.3. Switch interface

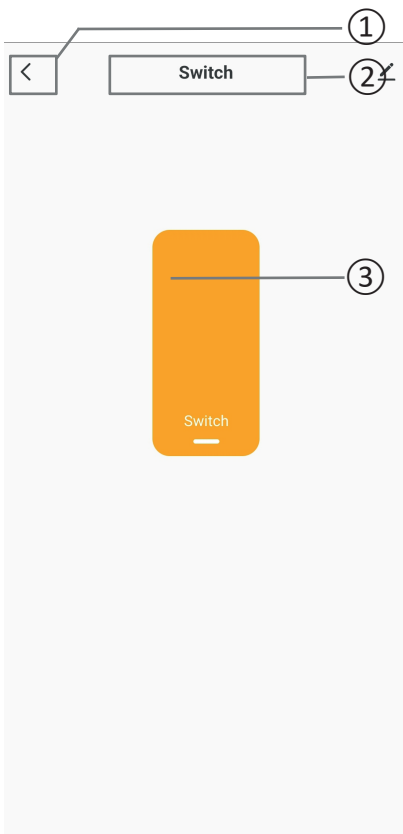

Fig.7.2(1) Switch interface

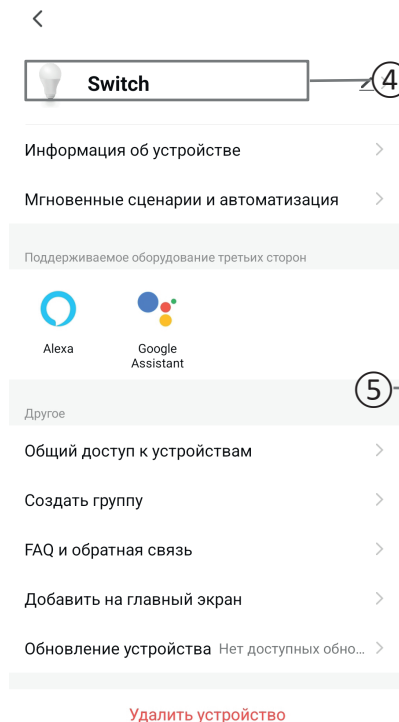

Fig.7.2(2) Device basic settings

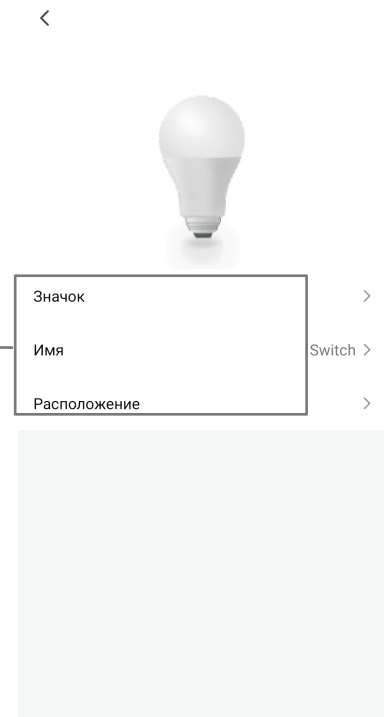



Fig.7.2(3) Info editing interface

① Return to the previous interface.

② Device name, shown it above the interface. Click icon  to go to figure7.2(2), you can view, change device settings, and remove devices.

Device basic settings as shown in figure 7.2 (2), including Device Information, Tap-to-Run and Automation, Other settings, and Remove Device. Set the Tap-to-Run and Automation via KNX scene switch, details in chapter 7.7.

Click ④ to go to figure7.2(3), you can edit current device name, icon and location.

③ Switch button, gray indicates status off, bright color indicates status on. Used for switching of switch status.



## 7.4. Switch/Dimming interface

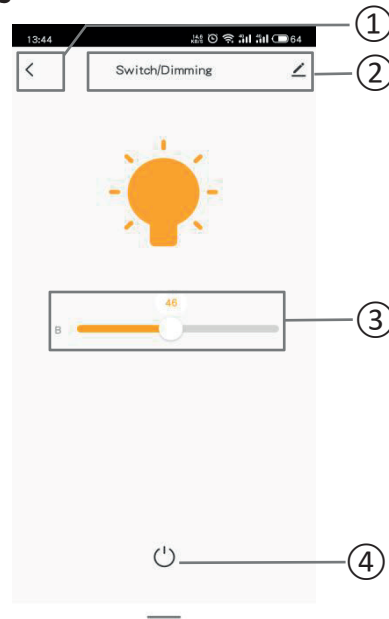



Fig.7.4(1) Switch/Dimming interface

①Return to the previous interface.

②Device name, shown it above the interface. Click icon , you can view, change device settings, and remove devices.

③B: brightness adjustment. Adjust brightness by sliding this slider, range: 0..100%

④LED switch button, gray indicates status off, bright color indicates status on. Used for switching of switch status. When brightness value is not 0, touch this button to close brightness, and value is 0.

## 7.5. RGB Dimming interface



Fig.7.5(1) RGB dimming interface



Fig.7.5(2) RGBW dimming interface



Fig.7.5(3) Color temperature

① Return to the previous interface.

② Device name, shown it above the interface. Click icon , you can view, change device settings, and remove devices.

There are 3 control types of RGB dimming function: RGB, RGBW, Color Temperature. Among them, RGB is suitable for adjusting RGB lamp; RGBW is suitable for controlling RGBW strip; Color Temperature is suitable for color temperature control. Shown as figure7.5(1)(2)(3).

③ RGB value adjustment. Adjust brightness by sliding R/G/B slider, range: 0..255

④ RGBW value adjustment. Adjust brightness by sliding R/G/B/W slider, range: 0..255

⑤ B: brightness adjustment. Adjust brightness by sliding this slider, range: 0..100%

CW: color temperature adjustment. Adjust color temperature by sliding this slider, range: 2000..7000K

⑥ LED switch button, gray indicates status off, bright color indicates status on. When current value is not 0, touch this button to close R/G/B/W or B/CW, and value is 0.

## 7.6. Curtain control interface

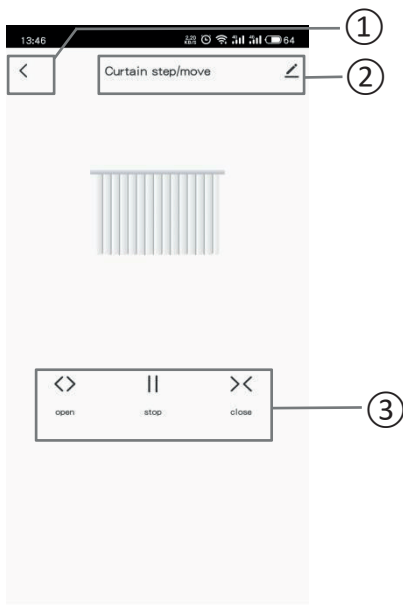

Fig.7.6(1)Curtain step/move position

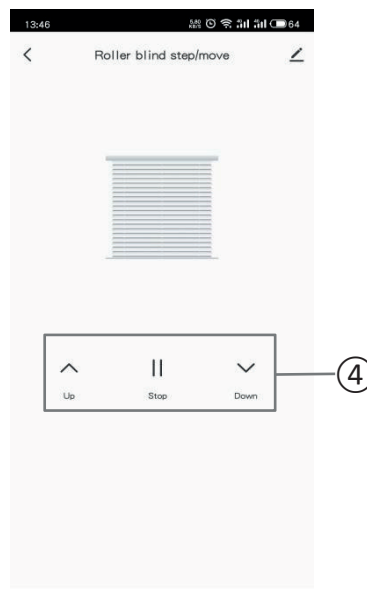

Fig.7.6(2)Roller blind step/move

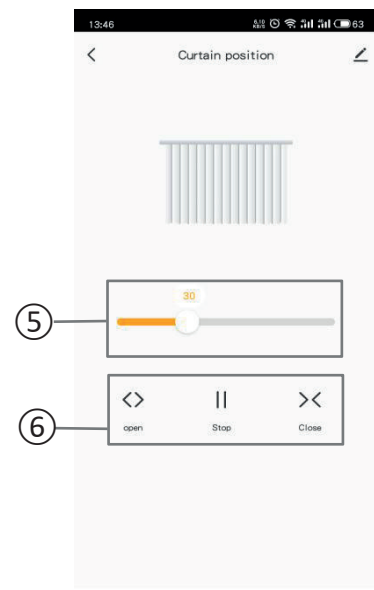

Fig.7.6(3)Curtain

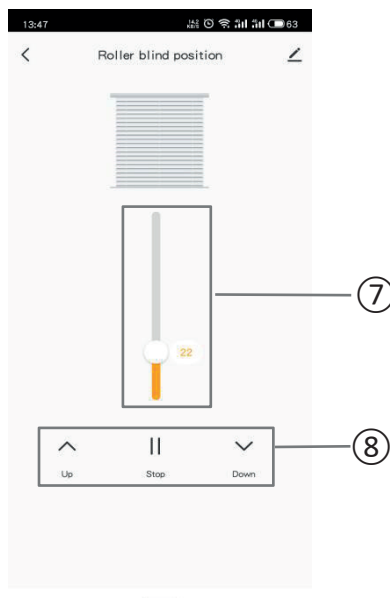

Fig.7.6(4)Roller blind position

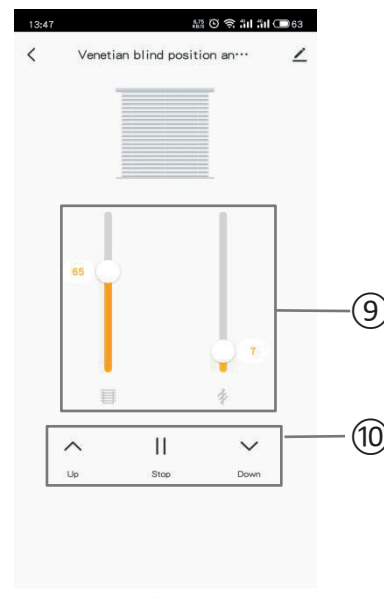





Fig.7.6(5)Venetian blind position and slat

①Return to the previous interface.

②Device name, shown it above the interface. Click icon , you can view, change device settings, and remove devices.

③Curtain step/move:



1)Touch icon , open curtain. Device sends out a telegram with the object(Open/Close) value of 0;

2)Touch icon , stop curtain. Device sends out a telegram with the object(Stop) value of 1;





3)Touch icon , close curtain. Device sends out a telegram with the object(Open/Close) value of 1;

1;





④ Rollerblind step/move:

- 1) Touch icon , move up blind. Device sends out a telegram with the object(Up/Down) value of 0;
- 2) Touch icon , stop blind. Device sends out a telegram with the object(Stop) value of 1;
- 3) Touch icon , move down blind. Device sends out a telegram with the object(Up/Down) value of 1;





⑤⑥ Curtain position:

- 1) By sliding the slider  to adjust the position of curtain;
- 2)    Operation of Open/Close/Stop are the same as above.

⑦⑧ Rollerblind position:

- 1) By sliding the slider  to adjust the position of blind;
- 2)    Operation of Up/Down/Stop are the same as above.

⑨⑩ Venetian blind position and slat:

- 1) By sliding the slider  to adjust the position and louver angle of venetian blind;
- 2)    Operation of Up/Down/Stop are the same as above.

## 7.7. Value sender interface

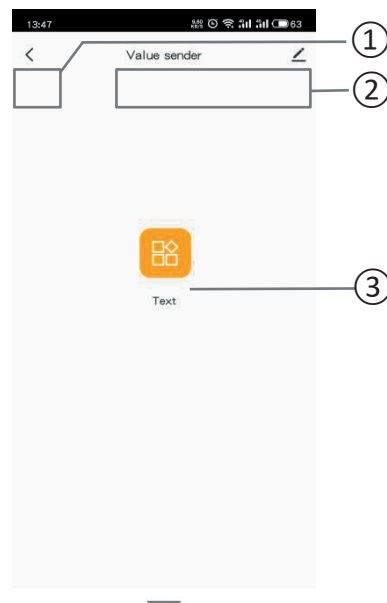



Fig.7.7. Value sender

① Return to the previous interface.

② Device name, shown it above the interface. Click icon , you can view, change device settings, and remove devices.

③ Touch icon, send telegram to KNX bus. Only used to trigger calling command on the APP, with only button operation.

There are 8 value types sent: 1bit[On/Off], 2bit[0..3], 1byte[0..255], 1byte[0..100%], 1byte[scene control], 2byte[-671 088.64..670 760.96], 2byte[0..65535].

## 7.8. KNX Scene switch interface

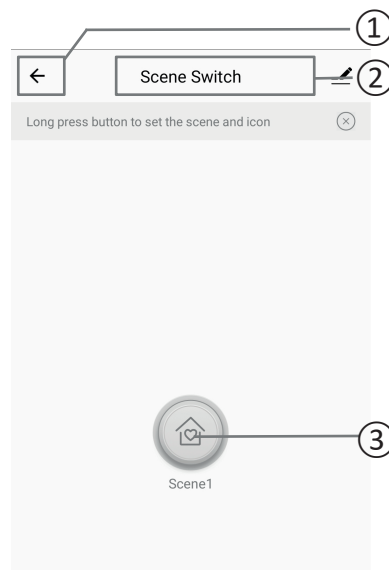



Fig.7.8(1) Scene switch interface

- ① Return to the previous interface.
- ② Device name, shown it above the interface. Click icon , you can view, change device settings, and remove devices.
- ③ Long press to enter the scene setting, receive KNX scene calling command, or short press on the APP to perform action set in scene setting, link the KNX device functions to the ZigBee on the APP. Configure specific associated devices and trigger responses for scene on the APP before operation.

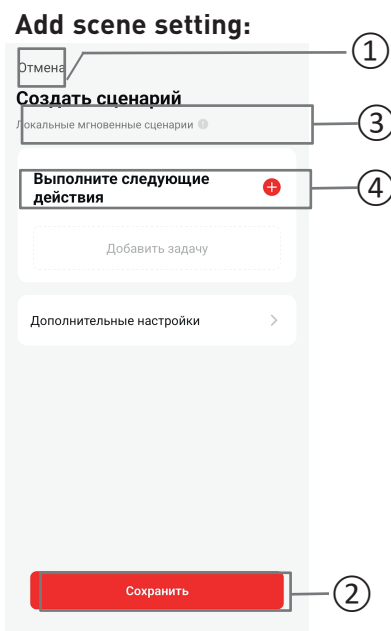

Fig.7.8(2) Scene switch setting

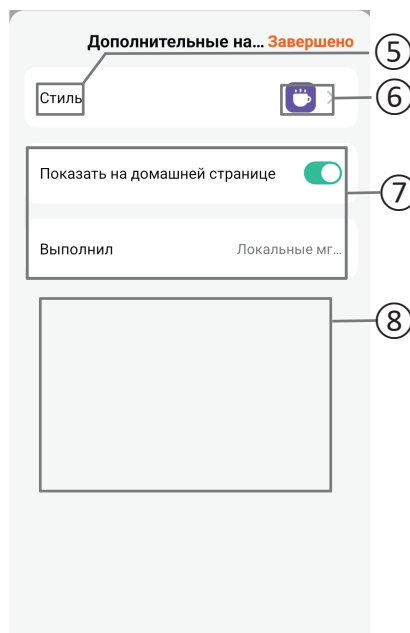

Fig.7.8(3) Create Smart

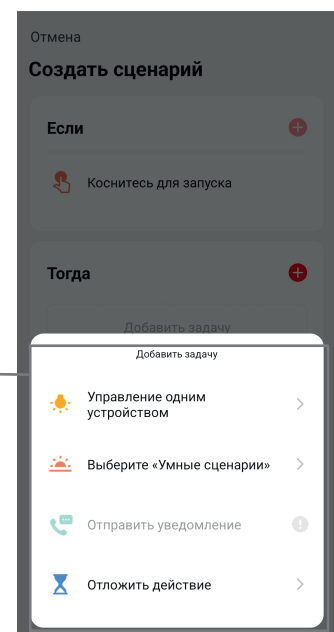

Fig.7.8(4) Add task

- ①⑤ Return to the previous interface.
- ② Click to save the setting and return to the previous interface after scene switch setting.

- ③ Click to modify scene icon.
- ④ Click to go to the interface Create Smart, shown as figure 7.7(3).
- ⑥ Click to save the setting and return to the previous interface after creating smart.
- ⑦ Click plus icon to create “Tap-To-Run” task, the window ⑨ is pop up below, you can select required setting, including: all devices, smart scenes, notification and the action delay. Task is shown in figure 7.7(3) after creating successfully.
- ⑧ Set the task name, display style, and whether to show on home page.

**Manage scene setting:**

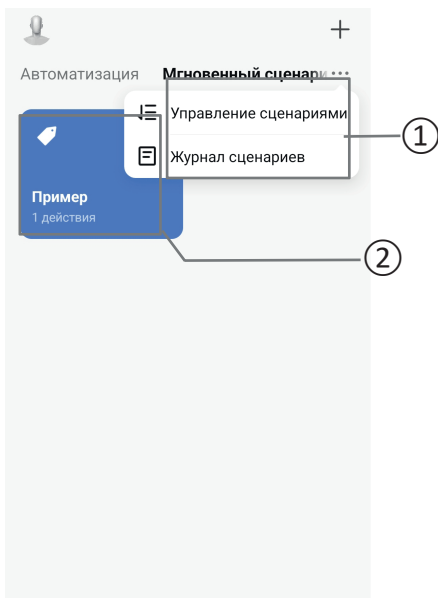

Fig.7.8(5) Smart interface

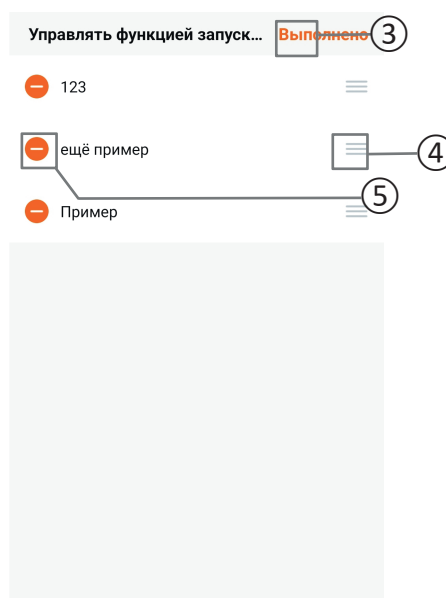

Fig.7.8(6) Manage interface

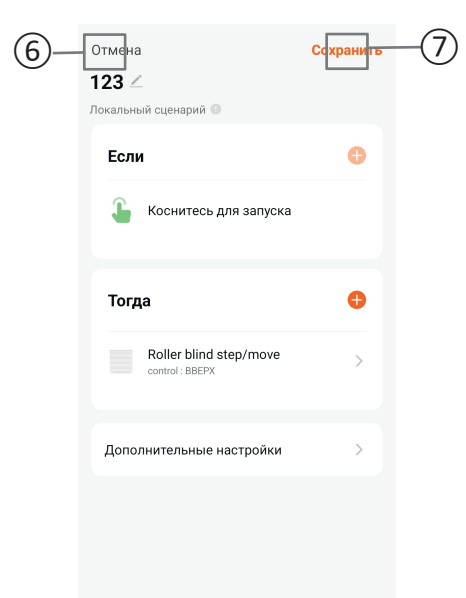

Fig.7.8(7) Edit interface

- ① Click three-point icon, display drop-down window, you can select **【Manage】** or **【Logs】**, shown as figure 7.8(5). Click **【Manage】** to go to manage interface, shown as figure 7.8(6). Long press icon ④ to slide, to adjust the order of scene tasks; click icon ⑤ to delete the scene task.
- ② Click three-point icon, go to the scene edit interface, shown as 7.8(7), operation in the interface: add task, change the task name and display style, whether to show on home page, and delete the scene. Click on the rest of the control to perform the scene immediately. Operate the edit interface also can be via the single device, such as figure 7.2 (2) device basic setting, to click Tap-to-Run and Automation.
- ③ Click to save and return to previous interface after task management.
- ⑥ Click to cancel edit, and return to previous interface.
- ⑦ Click to save and return to previous interface after editing.

## 7.9. Air condition interface

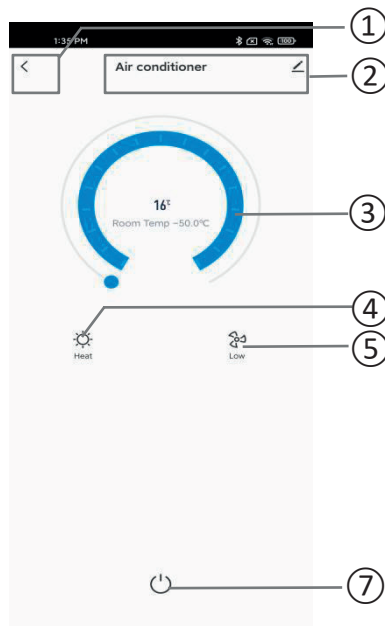

Fig.7.9(1) Air condition interface

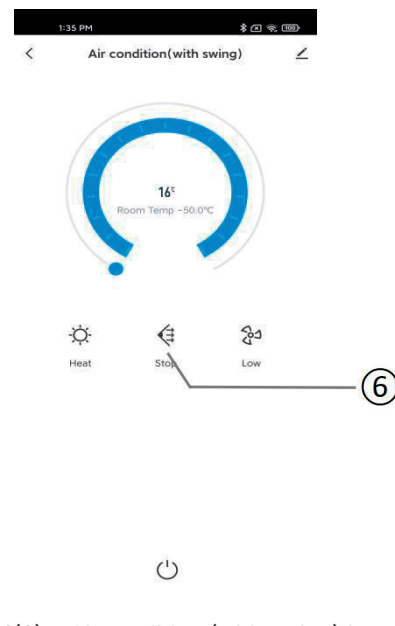













Fig.7.9(2) Air condition (with swing) interface

- ① Return to the previous interface.
- ② Device name, shown it above the interface. Click icon , you can view, change device settings, and remove devices.
- ③ Ring slider is used to adjust the setpoint temperature, the performed adjustment step is 1°. When temperature unit is set to degrees Celsius (°), adjustment range of setpoint temperature is default as 16 ~ 32°; Current temperature display according the parameter configuration, you can configure to show detected temperature of internal sensor or external sensor.
- ④ Click this icon to switch Air condition control mode, update the mode status via the object: Heat , Cool , Dehumidification , Fan , Auto .
- ⑤ Click this icon to switch fan speed, the current fan speed is cyclically switched in this order--Low speed...AUTO...Low speed: Low speed , Medium speed , High speed , Auto .
- ⑥ Click this icon switch swing control: swing , stop .
- ⑦ Air condition switch button, gray indicates status off, bright color indicates status on. When power off, except for the status of power on/off, the other icon status can not be updated via the bus or manually controlled. Click this icon, device sends a telegram of value 1/0 (On/Off) via the object Power on/off.



## 7.10. Room temperature unit interface

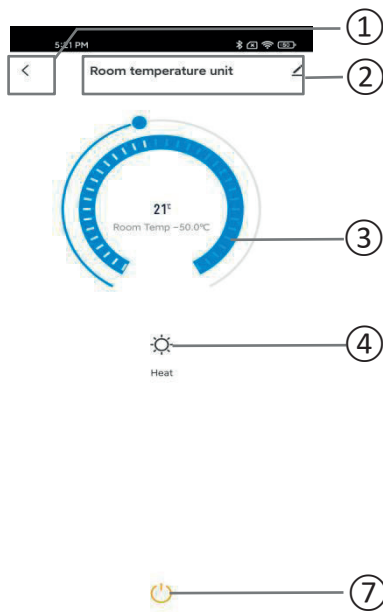

Fig.7.10 (1) RTC interface

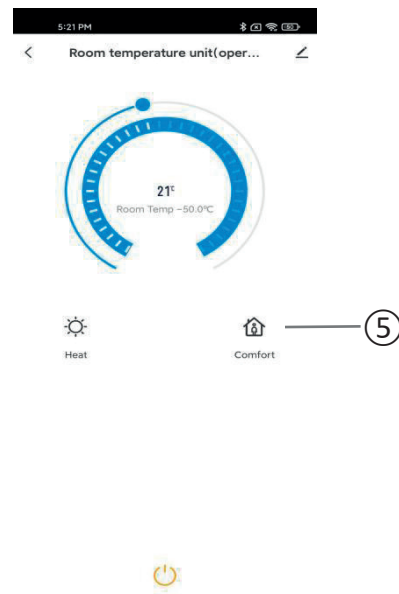

Fig.7.10 (2) RTC (with operation mode) interface

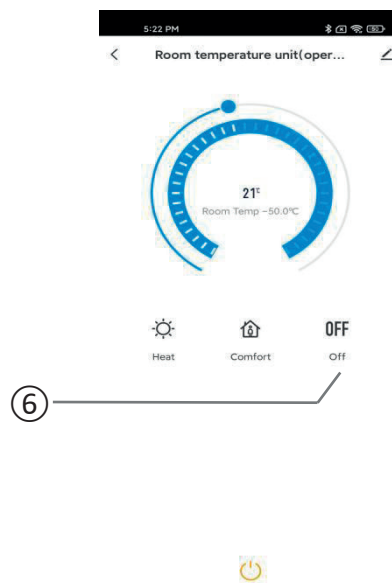





Fig.7.10 (3) RTC (with operation mode&fan)

① Return to the previous interface.

② Device name, shown it above the interface. Click icon , you can view, change device settings, and remove devices.





③ Ring slider is used to adjust the setpoint temperature, the performed adjustment step is 1°. When temperature unit is set to degrees Celsius (°), adjustment range of setpoint temperature is default as 5 ~ 40°; Current temperature display according the parameter configuration, you can configure to

show detected temperature of internal sensor or external sensor.

④ Click this icon to switch control mode, update the mode status via the object: Heating , cooling. .

You can switch the mode via touch or telegram when the database sets the RTC control mode to "Heating and Cooling".

⑤ Click this icon to switch operation mode: comfort , standby , economy , protection

⑥ Click this icon to switch fan speed, the current fan speed is cyclically switched in this order--Low speed...AUTO...Low speed: Low speed , Medium speed , High speed , Auto .

⑦ RTC switch button, gray indicates status off, bright color indicates status on. When power off, except for the status of power on/off, the other icon status can not be updated via the bus or manually controlled. Click this icon, device sends a telegram of value 1/0 (On/Off) via the object Power on/off.

### 7.11. Ventilation system interface

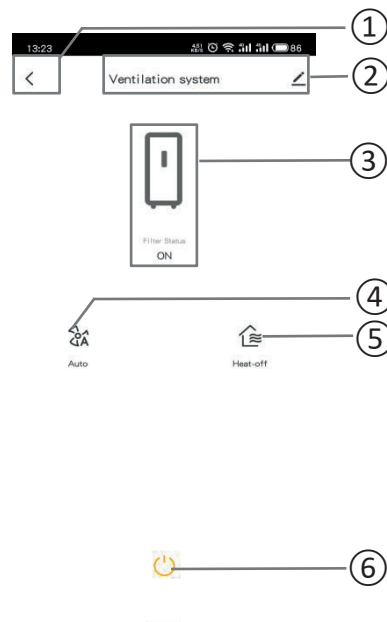







Fig. 7.11. Ventilation system control interface

- ① Return to the previous interface.
- ② Device name, shown it above the interface. Click icon , you can view, change device settings, and remove devices.
- ③ It is used to display the switch status of filter.
- ④ Click this icon to switch fan speed, the current fan speed is cyclically switched in this order--Low speed...AUTO...Low speed: Low speed , Medium speed , High speed , Auto .
- ⑤ Click the icon  to turn on or off heat recovery function.
- ⑥ Ventilation switch button, gray indicates status off, bright color indicates status on. When power off, except for the status of power on/off, the other icon status can not be updated via the bus or manually controlled. Click this icon, device sends a telegram of value 1/0 (On/Off) via the object Power on/off.

## 7.12. Audio control interface

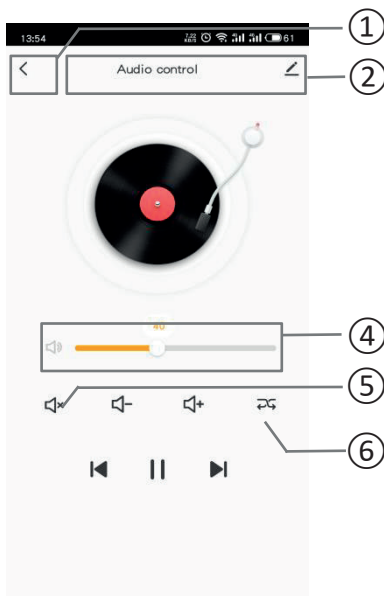

Fig.7.12 (1) Audio control interface

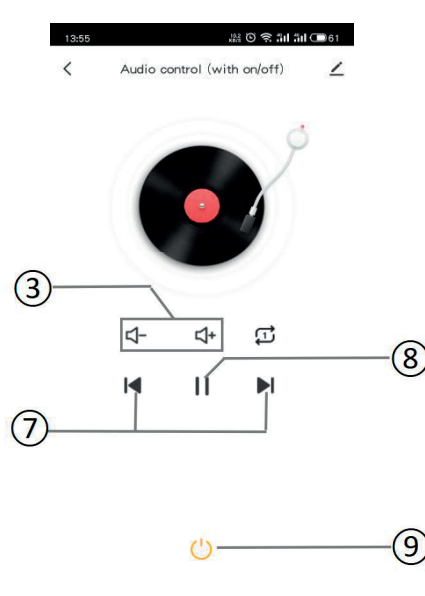





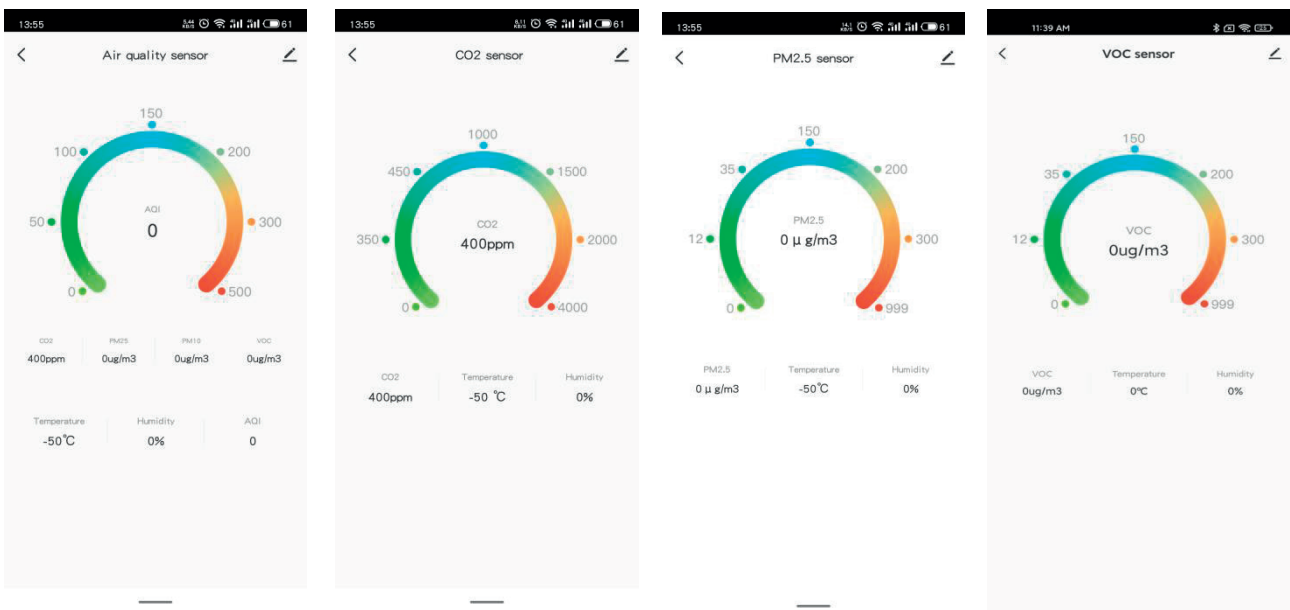

Fig.7.12 (2) Audio control (with on/off) interface

- ① Return to the previous interface.
- ② Device name, shown it above the interface. Click icon , you can view, change device settings, and remove devices.
- ③ Click the icon to adjust the volume in increasing or decreasing increments.
- ④ Slide the slider to adjust the volume decrease/increase.

- ⑤ Click the icon to mute/exit mute: mute , exit mute .
- ⑥ Click the button to switch the audio play mode. Update the status via the object: single loop , list play , random play .
- ⑦ Click the icon to select previous song or next song.
- ⑧ Click the icon to play or stop music. And update the status via the object.
- ⑨ Audio control switch button, gray indicates status off, bright color indicates status on. When power off, except for the status of power on/off, the other icon status can not be updated via the bus or manually controlled. Click this icon, device sends a telegram of value 1/0 (On/Off) via the object Power on/off.

### 7.13. Sensor interface



Air quality sensor interface

CO2 sensor interface

PM2.5 sensor interface

VOC sensor interface

Air quality sensor displays 7 reference values, independently is: CO2, PM2.5, PM10, VOC, Temperature, Humidity, AQI. What displays can be configured through the database. The CO2, PM2.5 and VOC have separate detectors, and all can show the internal temperature and humidity on the interface.

The ring on the interface and the reference values of corresponding devices. The update of the display value can be achieved by rewriting the object via the bus.

Detection range of AQI: 0..500

Detection range of CO2: 0..4000ppm

Detection range of PM2.5: 0..999ug/m<sup>3</sup>

Detection range of VOC: 0..999ug/m<sup>3</sup>

Detection range of temperature: -50...90°

Detection range of humidity: 0..100%

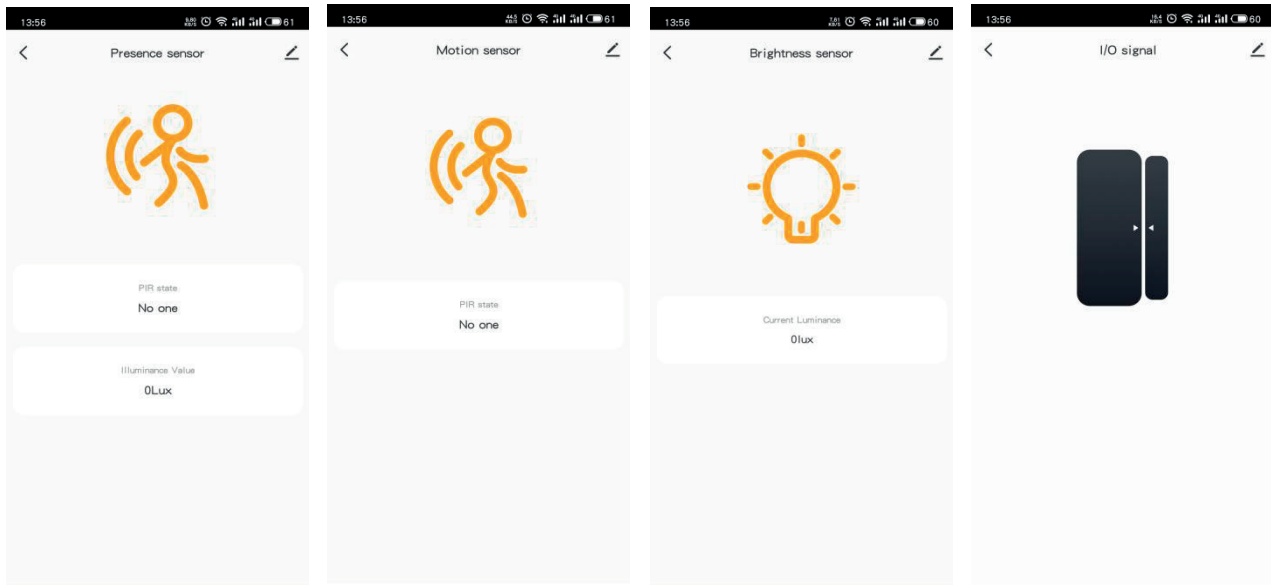

Presence sensor interface

Motion sensor interface

Brightness sensor interface

I/O signal interface

Presence sensor can detect PIR state, and illuminance, detection range: 0...65535lux

Motion sensor can detect PIR state.

Brightness sensor can detect the illuminance, detection range: 0...65535lux

I/O signal can detect the device switch status.

## 7.14. Current/Energy metering interface

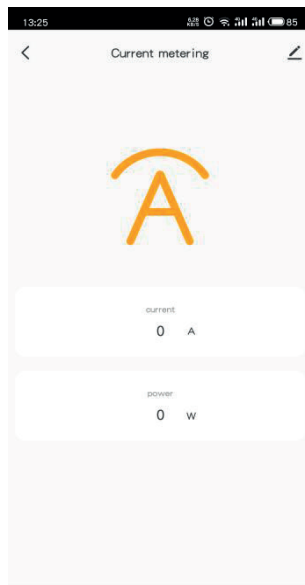

Currentmetering

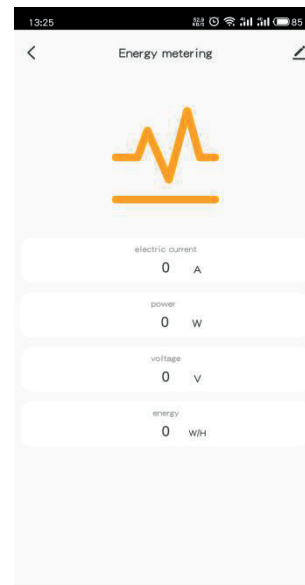

Energy metering

Current metering detects the current and power, and display the changing status in real-time, the values unit and resolution can be rewrite via the object on the bus.

Energy metering detects the current, power, voltage and energy, and display the changing status in real-time, the values unit and resolution can be rewrite via the object on the bus.

## 7.15. Voice control command

This chapter mainly list the voice control commands for Tuya Smart APP. You can find the command of ETS function to voice control. **Note: Currently , only the devices listed below are supported.**

ETS functions	Voice control command Note: the specific content in < > is determined by the name edited on the APP. Only support English. The same as below.	
	Amazon Alexa	Google Assistant
Switch	Alexa, turn on <device name> Alexa, turn off <device name>	OK Google, turn on <device name> OK Google, turn off <device name>
Switch/Dimming	<b>Switch:</b> Alexa, turn on <device name> Alexa, turn off <device name> <b>Dimming:</b> Alexa, set the bedroom light to fifty percent Alexa, brighten <device name> Alexa, dim <device name>	<b>Switch:</b> OK Google, turn on <device name> OK Google, turn off <device name> <b>Dimming:</b> OK Google, what is the brightness level of <device name>? OK Google, adjust <device name> to 65% brightness OK Google, brighten the <device name> OK Google, dim the <device name>
RGB Dimming	<b>Switch:</b> Alexa, turn on <device name> Alexa, turn off <device name>	<b>Switch:</b> OK Google, turn on <device name> OK Google, turn off <device name>
RGBW Dimming	<b>Switch:</b> Alexa, turn on <device name> Alexa, turn off <device name>	<b>Switch:</b> OK Google, turn on <device name> OK Google, turn off <device name>
Color Temperature	<b>Switch:</b> Alexa, turn on <device name> Alexa, turn off <device name> <b>Dimming:</b> Alexa, set the bedroom light to fifty percent Alexa, brighten <device name> Alexa, dim <device name>	<b>Switch:</b> OK Google, turn on <device name> OK Google, turn off <device name>

ETS functions	Voice control command	
	Amazon Alexa	Google Assistant
Color Temperature	<p><b>Color temperature:</b></p> <p>Alexa, make the living room lights warmer</p> <p>Alexa, set the dining room lights cooler</p> <p>Alexa, set the dining room softer</p> <p>Alexa, make the living room light whiter</p> <p>Alexa, make the living room light warm white</p> <p>Alexa, set the kitchen to daylight</p>	<p><b>Dimming:</b></p> <p>OK Google, what is the brightness level of &lt;device name&gt;?</p> <p>OK Google, adjust &lt;device name&gt; to 65% brightness</p> <p>OK Google, brighten the &lt;device name&gt;</p> <p>OK Google, dim the &lt;device name&gt;</p> <p><b>Color temperature:</b></p> <p>OK Google, set the &lt;device name&gt; to cool white</p>
Curtain step/move	<p><b>Curtain switch:</b></p> <p>Alexa, turn on &lt;device name&gt;</p> <p>Alexa, turn off &lt;device name&gt;</p>	<p><b>Curtain switch:</b></p> <p>OK Google, turn on &lt;device name&gt;</p> <p>OK Google, turn off &lt;device name&gt;</p> <p><b>Work status:</b></p> <p>OK Google, pause &lt;device name&gt;</p> <p>OK Google, resume &lt;device name&gt;</p>
Rollerblind step/move	<p><b>Curtain switch:</b></p> <p>Alexa, turn on &lt;device name&gt;</p> <p>Alexa, turn off &lt;device name&gt;</p>	<p><b>Curtain switch:</b></p> <p>OK Google, turn on &lt;device name&gt;</p> <p>OK Google, turn off &lt;device name&gt;</p> <p><b>Work status:</b></p> <p>OK Google, pause &lt;device name&gt;</p> <p>OK Google, resume &lt;device name&gt;</p>
Curtain position	<p><b>Curtain switch:</b></p> <p>Alexa, turn on &lt;device name&gt;</p> <p>Alexa, turn off &lt;device name&gt;</p> <p><b>Percentage position:</b></p> <p>Alexa, set the &lt;device name&gt; to thirty percent</p> <p>Alexa, increase &lt;device name&gt; by ten percent</p> <p>Alexa, decrease &lt;device name&gt; by twenty percent</p>	<p><b>Curtain switch:</b></p> <p>OK Google, turn on &lt;device name&gt;</p> <p>OK Google, turn off &lt;device name&gt;</p> <p><b>Work status:</b></p> <p>OK Google, pause &lt;device name&gt;</p> <p>OK Google, resume &lt;device name&gt;</p> <p><b>Percentage position:</b></p> <p>OK Google, open &lt;device name&gt;</p> <p>OK Google, close &lt;device name&gt;</p>



ETS functions	Voice control command	
	Amazon Alexa	Google Assistant
Rollerblind position	<p><b>Curtain switch:</b> Alexa, turn on &lt;device name&gt; Alexa, turn off &lt;device name&gt;</p> <p><b>Percentage position:</b> Alexa, set the &lt;device name&gt; to thirty percent Alexa, increase &lt;device name&gt; by ten percent Alexa, decrease &lt;device name&gt; by twenty percent</p>	<p><b>Curtain switch:</b> OK Google, turn on &lt;device name&gt; OK Google, turn off &lt;device name&gt;</p> <p><b>Work status:</b> OK Google, pause &lt;device name&gt; OK Google, resume &lt;device name&gt;</p> <p><b>Percentage position:</b> OK Google, open &lt;device name&gt; OK Google, close &lt;device name&gt;</p>
Venetian blind position and slat	<p><b>Curtain switch:</b> Alexa, turn on &lt;device name&gt; Alexa, turn off &lt;device name&gt;</p> <p><b>Work status:</b> Alexa, pause device Alexa, resume device</p>	<p><b>Curtain switch:</b> OK Google, turn on &lt;device name&gt; OK Google, turn off &lt;device name&gt;</p> <p><b>Work status:</b> OK Google, start the washing machine OK Google, stop &lt;device name&gt;</p>
Value sender /Scene switch	<p>Alexa, turn on &lt;device name&gt; Alexa, turn off &lt;device name&gt;</p>	<p>OK Google, turn on &lt;device name&gt; OK Google, turn off &lt;device name&gt;</p>
Air conditioner	<p><b>Power:</b> Alexa, turn on &lt;device name&gt; Alexa, turn off &lt;device name&gt;</p> <p><b>Control mode:</b> Alexa, set the &lt;mode name&gt; on the &lt;device name&gt; to &lt;mode value&gt;</p> <p><b>Temperature:</b> Alexa, make it warmer in here Alexa, make it cooler in here Alexa, what is the target temperature of the &lt;device name&gt;? Alexa, set &lt;device name&gt; to twenty Alexa, set &lt;device name&gt; to N</p> <p><b>Check actual temperature:</b> Alexa, what is the temperature of &lt;device name&gt;</p> <p><b>Fan speed level:</b> Alexa, set the fan speed on the &lt;device name&gt; to &lt;mode value&gt;</p>	<p><b>Power:</b> OK Google, turn on &lt;device name&gt; OK Google, turn off &lt;device name&gt;</p> <p><b>Control mode:</b> OK Google, set &lt;device name&gt; to &lt;mode value&gt;</p> <p><b>Temperature:</b> OK Google, set the &lt;device name&gt; to 350 degrees</p> <p><b>Check actual temperature:</b> OK Google, what is the current device temperature?</p> <p><b>Fan speed level:</b> OK Google, set the &lt;device name&gt; to low OK Google, set the &lt;device name&gt; to high</p>

ETS functions	Voice control command	
	Amazon Alexa	Google Assistant
Air condition (with swing)	<p><b>Power:</b> Alexa, turn on &lt;device name&gt; Alexa, turn off &lt;device name&gt;</p> <p><b>Control mode:</b> Alexa, set the &lt;mode name&gt; on the &lt;device name&gt; to &lt;mode value&gt;</p> <p><b>Temperature:</b> Alexa, make it warmer in here Alexa, make it cooler in here Alexa, what is the target temperature of the &lt;device name&gt;? Alexa, set &lt;device name&gt; to twenty Alexa, set &lt;device name&gt; to N</p> <p><b>Check actual temperature:</b> Alexa, what is the temperature of &lt;device name&gt;</p> <p><b>Fan speed level:</b> Alexa, set the fan speed on the &lt;device name&gt; to &lt;mode value&gt;</p> <p><b>Swing:</b> Alexa, turn on horizontal swing on &lt;device name&gt; Alexa, turn off horizontal swing on &lt;device name&gt;</p>	<p><b>Power:</b> OK Google, turn on &lt;device name&gt; OK Google, turn off &lt;device name&gt;</p> <p><b>Control mode:</b> OK Google, set &lt;device name&gt; to &lt;mode value&gt;</p> <p><b>Temperature:</b> OK Google, set the &lt;device name&gt; to 350 degrees</p> <p><b>Check actual temperature:</b> OK Google, what is the current device temperature?</p> <p><b>Fan speed level:</b> OK Google, set the &lt;device name&gt; to low OK Google, set the &lt;device name&gt; to high</p> <p><b>Swing:</b> Turn on/off &lt;device name&gt;</p>

ETS functions	Voice control command	
	Amazon Alexa	Google Assistant
Room temperature unit	<p><b>Power:</b></p> <p>Alexa, turn on &lt;device name&gt;</p> <p>Alexa, turn off &lt;device name&gt;</p> <p><b>Control mode:</b></p> <p>Alexa, set the &lt;mode name&gt; on the &lt;device name&gt; to &lt;mode name&gt;</p> <p><b>Temperature:</b></p> <p>Alexa, make it warmer in here</p> <p>Alexa, make it cooler in here</p> <p>Alexa, what is the target temperature of the &lt;device name&gt;?</p> <p>Alexa, set &lt;device name&gt; to twenty</p> <p>Alexa, set &lt;device name&gt; to N</p> <p><b>Check actual temperature:</b></p> <p>Alexa, what is the temperature of &lt;device name&gt;</p>	<p><b>Power:</b></p> <p>OK Google, turn on &lt;device name&gt;</p> <p>OK Google, turn off &lt;device name&gt;</p> <p><b>Control mode:</b></p> <p>OK Google, set &lt;device name&gt; to &lt;mode value&gt;</p> <p><b>Temperature:</b></p> <p>OK Google, set the &lt;device name&gt; to 350 degrees</p> <p><b>Check actual temperature:</b></p> <p>OK Google, what is the current device temperature?</p>
Room temperature unit (with operation mode)	<p><b>Power:</b></p> <p>Alexa, turn on &lt;device name&gt;</p> <p>Alexa, turn off &lt;device name&gt;</p> <p><b>Operation/Control mode:</b></p> <p>Alexa, set the &lt;mode name&gt; on the &lt;device name&gt; to &lt;mode name&gt;</p> <p><b>Temperature:</b></p> <p>Alexa, make it warmer in here</p> <p>Alexa, make it cooler in here</p> <p>Alexa, what is the target temperature of the &lt;device name&gt;?</p> <p>Alexa, set &lt;device name&gt; to twenty</p> <p>Alexa, set &lt;device name&gt; to N</p> <p><b>Check actual temperature:</b></p> <p>Alexa, what is the temperature of &lt;device name&gt;</p>	<p><b>Power:</b></p> <p>OK Google, turn on &lt;device name&gt;</p> <p>OK Google, turn off &lt;device name&gt;</p> <p><b>Operation/Control mode:</b></p> <p>OK Google, set &lt;device name&gt; to &lt;mode value&gt;</p> <p><b>Temperature:</b></p> <p>OK Google, set the &lt;device name&gt; to 350 degrees</p> <p><b>Check actual temperature:</b></p> <p>OK Google, what is the current device temperature?</p>

ETS functions	Voice control command	
	Amazon Alexa	Google Assistant
Room temperature unit (with operation mode & fan speed)	<p><b>Power:</b> Alexa, turn on &lt;device name&gt; Alexa, turn off &lt;device name&gt;</p> <p><b>Operation/Controlmode:</b> Alexa, set the &lt;mode name&gt; on the &lt;device name&gt; to &lt;mode name&gt;</p> <p><b>Temperature:</b> Alexa, make it warmer in here Alexa, make it cooler in here Alexa, what is the target temperature of the &lt;device name&gt;? Alexa, set &lt;device name&gt; to twenty Alexa, set &lt;device name&gt; to N</p> <p><b>Check actual temperature:</b> Alexa, what is the temperature of &lt;device name&gt;</p> <p><b>Fan speed level:</b> Alexa, set the fan speed on the &lt;device name&gt; to &lt;mode value&gt;</p>	<p><b>Power:</b> OK Google, turn on &lt;device name&gt; OK Google, turn off &lt;device name&gt;</p> <p><b>Operation/Controlmode:</b> OK Google, set &lt;device name&gt; to &lt;mode value&gt;</p> <p><b>Temperature:</b> OK Google, set the &lt;device name&gt; to 350 degrees</p> <p><b>Check actual temperature:</b> OK Google, what is the current device temperature?</p> <p><b>Fan speed level:</b> OK Google, set the &lt;device name&gt; to low OK Google, set the &lt;device name&gt; to high</p>
Ventilation system	<p><b>Power:</b> Alexa, turn on &lt;device name&gt; Alexa, turn off &lt;device name&gt;</p> <p><b>Fan speed level:</b> Alexa, set the fan speed on the &lt;device name&gt; to &lt;mode value&gt;</p>	

ETS functions	Voice control command	
	Amazon Alexa	Google Assistant
Audio control	<p><b>Volume:</b></p> <p>Alexa, set the volume of the speakers to fifty</p> <p>Alexa, turn the volume down on the stereo by twenty</p> <p>Alexa, turn the volume down on Living Room TV</p> <p>Alexa, mute speakers</p> <p>Alexa, unmute speakers</p> <p><b>Track change:</b></p> <p>Alexa, previous on device</p> <p>Alexa, next song/video/photo on device</p>	<p><b>Volume:</b></p> <p>OK Google, make the &lt;device name&gt; a little quieter</p> <p>OK Google, mute &lt;device name&gt;</p> <p><b>Mute mode:</b></p> <p>Turn on &lt;device name&gt;</p> <p>Turn off &lt;device name&gt;</p>
Audio control(with on/off)	<p><b>Power:</b></p> <p>Alexa, open &lt;device name&gt;</p> <p>Alexa, close &lt;device name&gt;</p> <p><b>Play/pause:</b></p> <p>Alexa, pause device</p> <p>Alexa, resume device</p> <p><b>Track change:</b></p> <p>Alexa, previous on device</p> <p>Alexa, next song/video/photo on device</p>	<p><b>Power:</b></p> <p>OK Google, turn on &lt;device name&gt;</p> <p>OK Google, turn off &lt;device name&gt;</p>
Air quality sensor	<p><b>Temperature check:</b></p> <p>Alexa, what is the temperature of &lt;device name&gt;</p> <p><b>Humidity check:</b></p> <p>Alexa, what is the bedroom humidity?</p> <p><b>CO2 check:</b></p> <p>Alexa, what's the &lt;device name&gt; &lt;range name&gt;?</p>	<p><b>Temperature check:</b></p> <p>OK Google, what is the current device temperature?</p> <p><b>Humidity check:</b></p> <p>OK Google, what humidity does my humidifier show?</p> <p><b>CO2 check:</b></p> <p>OK Google, is the &lt;sensor name&gt; detecting carbon dioxide</p> <p>OK Google, Is carbon dioxide detected</p> <p>OK Google, do you detect carbon dioxide in the room</p>

ETS functions	Voice control command	
	Amazon Alexa	Google Assistant
CO2 sensor	Alexa, what's the <device name> <range name>?	OK Google, is the <sensor name> detecting carbon dioxide OK Google, Is carbon dioxide detected OK Google, do you detect carbon dioxide in the room
Presence sensor	Alexa, what's the <device name> <range name>?	
Brightness sensor	Alexa, what's the <device name> <range name>?	

## Chapter 8. Tuya Zigbee Gateway Management System

Tuya Zigbee Gateway Management System only apply to **KNX Gateway for Tuya ZigBee, Premium**, use web to configure and manage the links between ZigBee devices and KNX system. Before enter to the system, please ensure that the gateway is connected to LAN correctly, then configure IP address and Zigbee channel via ETS. This management system only makes secondary configuration for the devices.

Ensure the computer and mobile phone is in the same LAN, then enter IP address of the gateway in the browser to enter Management System. The system operation and ZigBee device linking will be explained in the following chapters.

## 8.1. Gateway information

# Tuya Zigbee Gateway Management System

Gateway information	Overview					
ZigBee device list						
ZigBee function list						
IP	MAC	Default GW.	License account	License password	FW.version	
192.168.2.77	1c:87:76:91:3c:56	192.168.2.1	sskjc100dba3a7154011	yKoQOO0dEyT80AXEYJVgApni4hYtuoNs	02.02.09	

In the system, you can see the based information of the gateway, including the IP address, MAC address, default gateway address, Tuya license account and password, and firmware version.

Note: if description of ZigBee channel is set as Chinese character, please set the codepage of project to UTF-8 at first, or that will display abnormally on the Management System after download the ETS. The setting of codepage as shown as following:

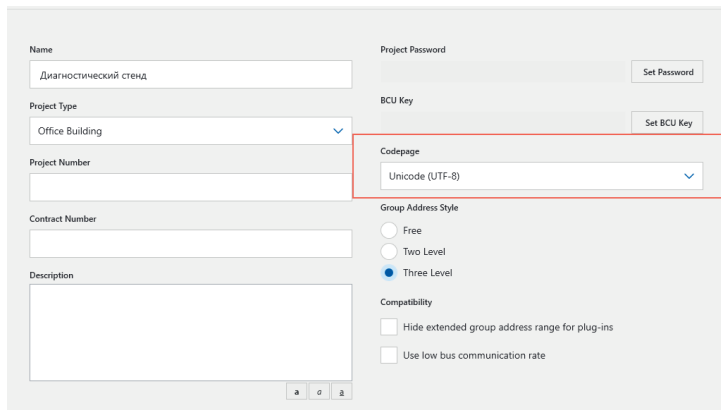

The screenshot shows a configuration form with the following fields and options:

- Name:** Диагностический стенд
- Project Type:** Office Building (dropdown)
- Project Number:** (empty text field)
- Contract Number:** (empty text field)
- Description:** (empty text area)
- Project Password:** (password field with 'Set Password' button)
- BCU Key:** (password field with 'Set BCU Key' button)
- Codepage:** Unicode (UTF-8) (dropdown menu, highlighted with a red box)
- Group Address Style:**
  - Free
  - Two Level
  - Three Level
- Compatibility:**
  - Hide extended group address range for plug-ins
  - Use low bus communication rate



## 8.2. ZigBee device list

# Tuya Zigbee Gateway Management System

Gateway information	Overview
ZigBee device list	
ZigBee function list	

Virtual ID	Name	MAC	Status	KNX Name	ZigBee Channel	Operation setting
1	Test dimmer	a4c138bcb6d35329	offline	dimmer	1	DVC FUN EDIT DEL
2	RGBCW device	a4c1380daa4ca19	online	rgbw	2	DVC FUN EDIT DEL
3		943469fffedbd518	offline			DVC FUN EDIT DEL

Showing 1 to 3 of 3 entries

First Previous 1 Next Last

Click “ZigBee device list”, you can view the information of ZigBee devices that are linked/to be linked. As follow:

Virtual ID	Assigned automatically by the system.
Name	Display ZigBee device name. User can customize the name, if it is not defined, it will be empty.
MAC	MAC address of the device.
Status	Online/Offline
KNX Name	The name configured in ETS.
ZigBee Channel	Display the bound ZigBee channel number, corresponding to the ETS setting, number is 1~32.
Operation setting	DVC: use to link the ZigBee device to corresponding ZigBee channel. FUN: use to link the ZigBee device to corresponding ZigBee function. EDIT: use to change ZigBee device name. DEL: use to delete the linking information of ZigBee device.

**Note: If the device is already linked, the DVC button is not operable. If the device is not linked, FUN/DEL buttons are not operable.**

### 8.3.ZigBee function list

## Tuya Zigbee Gateway Management System

Device	MAC	Fun.ID	Data mode	Status value	Device type	Linking
Test dimmer	a4c138bcb6d35329	1	Status/Control	0	Switch/Dimming	Switch
Test dimmer	a4c138bcb6d35329	3	Status/Control	0	Switch/Dimming	Brightness
RGBCW device	a4c13800daa4ca19	1	Status/Control	1		Switch
RGBCW device	a4c13800daa4ca19	3	Status/Control	728		Brightness
RGBCW device	a4c13800daa4ca19	4	Status/Control	31		Color Temp.
RGBCW device	a4c13800daa4ca19	5	Status/Control	009103e802d8		RGB color
	943469ffedbd518	1	Status	0	Switch3	Switch3
	943469ffedbd518	24	Status/Control	0	Switch3	Switch1
	943469ffedbd518	25	Status/Control	0	Switch3	Switch2

Showing 1 to 9 of 9 entries

First Previous 1 Next Last

Click “ZigBee function list”, you can view the information of ZigBee functions that are already linked. The detail operation you can refer to chapter 8.4.

**Device** Display device name, you can change it in “Operation setting” of “ZigBee device list”.

**MAC** Display MAC address of the device.

**Fun.ID** Display the function ID number that is linked.

**Data mode** Display the data transmission mode of the device. There are 3 modes:  
**Status:** ZigBee device only uploads the current status value to the management system or KNX;  
**Control:** ZigBee device only receives the control command from other terminals (such as APP and KNX).  
**Status/Control:** ZigBee device not only can upload the current status value, but also can receive the control command.

**Status value** Display the status value fed back from ZigBee device to KNX bus.  
**Note: data with decimal point is displayed as an integer, for example, the value is 26.7, and the system displays 267; The value is 77%, and the system displays 766.**

**Device type** Display the ZigBee device type, according to the linked channel and function.

**Linking** Display the linked ZigBee function, you can change it in “Operation setting” of “ZigBee device list”.

## 8.4. Linking the ZigBee device

Operation of linking the ZigBee device is as follow:

(1) Firstly, configure ZigBee channel in ETS, including name, MAC address, device type and etc.. Then download to the gateway, add the gateway and sub devices to Tuya Smart APP according to chapter 7.1. Enter the gateway IP address in the browser into Tuya Zigbee Gateway Management System, it displays ZigBee devices that are linked/to be linked, as shown as follow:

Virtual ID	Name	MAC	Status	KNX Name	ZigBee Channel	Operation setting
1	Test dimmer	a4c138bcb6d35329	offline	dimmer	1	DVC FUN EDIT DEL
2	RGBCW device	a4c13800daa4ca19	online	rgbw	2	DVC FUN EDIT DEL
3		943469fffedbd518	offline	ZigBee4	4	DVC FUN EDIT DEL

Showing 1 to 3 of 3 entries

First Previous 1 Next Last

(2) Link KNX function. View the MAC address on the APP firstly, each ZigBee device has corresponding unique MAC address. Click the DVC button in “ZigBee device list” page, pop-up the setting page, then click on the “Function selection” drop-down box, select the corresponding function to link, and then display the KNX name, which is configured in ETS and can not change. “ZigBee Device Name” is customized by the user. Click “Submit” after completion.

Please select KNX function

MAC: 943469fffedbd518

KNX Name: Function selection

- Function selection
- dimmer
- rgbw
- ZigBee3
- ZigBee4
- ZigBee5

Please select KNX function

MAC: 943469fffedbd518

KNX Name: ZigBee6

ZigBee Device Name: Some Name

Submit

(3) After completing the last step, auto return to “ZigBee device list” page, when the column of the “ZigBee Channel” has number displayed, the device is linked to the ZigBee channel. At this time, the DVC button can no longer be operated.

3		943469fffedbd518	offline			DVC FUN EDIT DEL
---	--	------------------	---------	--	--	------------------

**Note:**

The same ZigBee channel can not be linked to multiple ZigBee devices, or it will pop-up the prompt to change channel.

If preset MAC address in ETS, as shown as follow, the gateway will assign the channel linking automatically to the ZigBee device with this MAC address. There is no need to do steps (2) and (3) on the system and DVC button is not operable at this time, it only need to operate step (4) to link the ZigBee function.

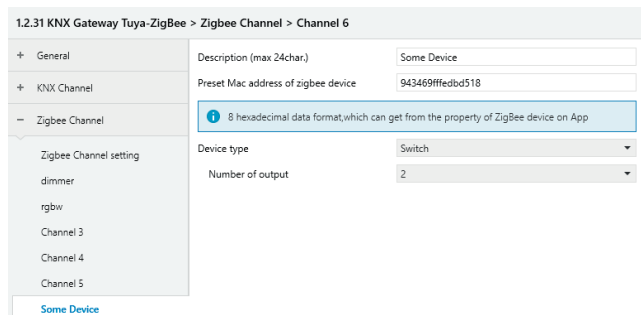

MAC address can be obtained from Device information in Tuya Smart APP. View the device MAC address as follow:

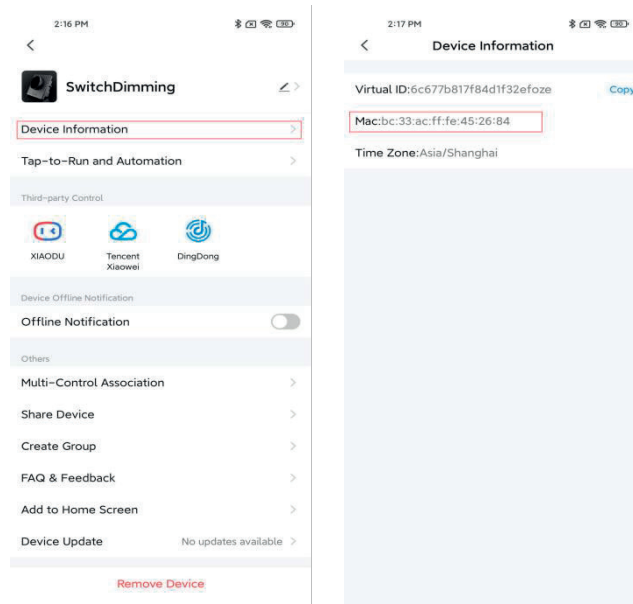

If not preset MAC address, system displays the ZigBee devices scanned by the gateway , follow the steps to link the ZigBee channel and function.

(4)Link the ZigBee function. When the device is linked the ZigBee channel, click the FUN button in the “ZigBee device list” page, pop-up the setting page, setting as follow:

ZigBee function list ×

Fun.ID	Type	Data mode	Status value	Linking	Operation setting
1	enum	Status	0		--Function selection-- ▾
2	enum	Status	0		--Function selection-- ▾
17	bool	Status/Control	0		--Function selection-- ▾
18	enum	Status/Control	0		--Function selection-- ▾
19	enum	Status/Control	0		--Function selection-- ▾
24	bool	Status/Control	0		--Function selection-- ▾
25	bool	Status/Control	0		--Function selection-- ▾
30	value	Status/Control	0		--Function selection-- ▾
31	value	Status/Control	0		--Function selection-- ▾
37	enum	Status/Control	0		--Function selection-- ▾

Showing 1 to 10 of 11 entries

First Previous 1 2 Next Last

- Fun.ID** Display the ZigBee function number.
- Type** Display the function type (bool, value, enumeration, character and etc.). Display the data mode of the function , there are 3 modes: Status; Control;Status/Control.
- Data mode**
- Status value** Display status value of the corresponding function.  
**Note: data with decimal point is displayed as an integer, for example, the value is 77%, and the system displays 766.**
- Linking** Display the linked ZigBee function.
- Operation setting** Operate ZigBee device function on the APP, if the status value in the setting page changes and is similar to the status information on the APP (If there are no changes, please refresh the system), then click on the “Function selection” drop-down box, select the corresponding function to link.  
 e.g: The dimming device with the MAC address bc33acfffe452684 is linked to the ZigBee channel on the system, then operate the device on the APP, Function ID1=1 and ID2=766 is corresponding to dimmer ON and brightness value 77% on the APP, as shown as above figure. Click the “Function selection” drop-down box according to the status value and select the corresponding function to link.  
 ZigBee function linking for other devices can be analogized.

(5)After completing the function linking, display the configured ZigBee device on the “ZigBee function list” page.

Device	MAC	Fun.ID	Data mode	Status value	Device type	Linking
Test dimmer	a4c138bcb6d35329	1	Status/Control	0	Switch/Dimming	Switch
Test dimmer	a4c138bcb6d35329	3	Status/Control	0	Switch/Dimming	Brightness
RGBCW device	a4c13800daa4ca19	1	Status/Control	1		Switch
RGBCW device	a4c13800daa4ca19	3	Status/Control	724		Brightness
RGBCW device	a4c13800daa4ca19	4	Status/Control	31		Color Temp.
RGBCW device	a4c13800daa4ca19	5	Status/Control	009103e802d4		RGB color

Showing 1 to 6 of 6 entries

First Previous **1** Next Last

(6)After completing the above steps, you can control ZigBee devices via KNX or Tuya Smart APP, and also can upload the current status of the ZigBee device to the cloud or KNX.

(7)Edit the device name. Click EDIT button on the “ZigBee device list” page, pop-up the setting page, enter the custom name in “Device Name” input box, click “OK”, then the device name can be replaced.

Name setting ×

---

**MAC:**  
a4c138bcb6d35329

**Device Name:**  
Test dimmer

(8)Remove the device linking. Click DEL button on the “ZigBee device list” page, pop-up the page to select whether to delete, click “OK”, then clean the linking information of the ZigBee device. As shown as follow.

Подтвердите действие на 192.168.2.77

Delete the record with id = 1?

**Note: After deletion, the item will be automatically arranged at the last of the list, and the FUN / DEL button are inoperable at this time.**

## Chapter 9. OTA for KNX Gateway for Tuya ZigBee

KNX Gateway for Tuya ZigBee upgrades new firmware remotely (OTA) via Tuya Smart APP.

Operation as follow:

(1)Enter the gateway home page, if there is a new device firmware released, the page will pop up the update reminder.If the new firmware is released but you do not receive the update, please contact Arlight technical support.

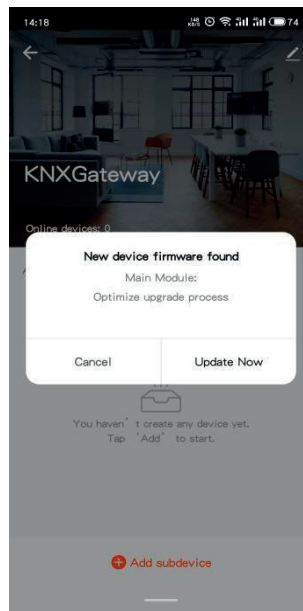

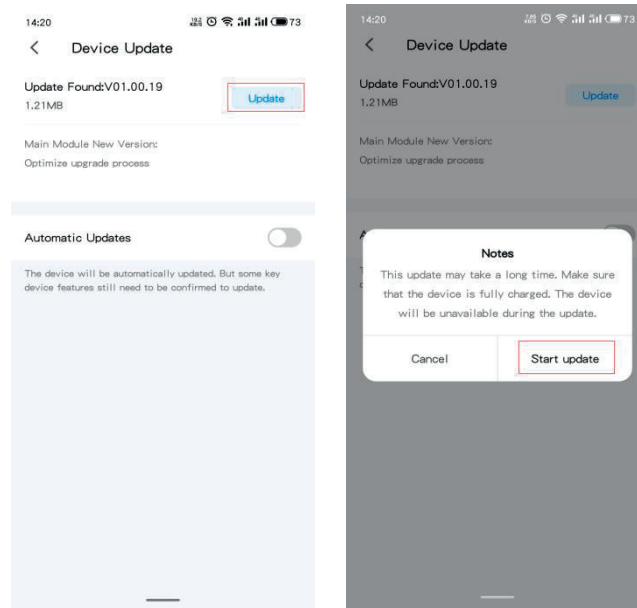

(2)Click “Update Now” to enter the Device Update page, which notes the Main Module New Version and the update content. Then click “Update”, pup up the update reminder,please ensure that the power supply for gateway is normal during updating, and it will be unavailable during the update, then click “Start update”.

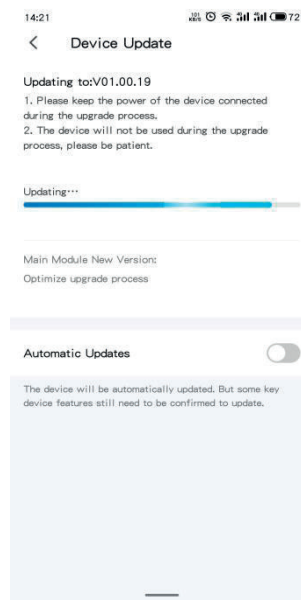

User can set the gateway to update automatically. But some key device features still need to be confirmed to update.

(4) After entering the update status, the page is shown in the figure below, please do not do anything at this time. Wait about 1 minute, the APP prompt update success.



(5) Check the device update. Click the icon  in the gateway home page to enter management page, click "Device Update", if upgraded, it will show "No updates available" and Main Module version; if there is a new update, you can follow these steps above to update.



